

# SPECIAL EDITION

2024

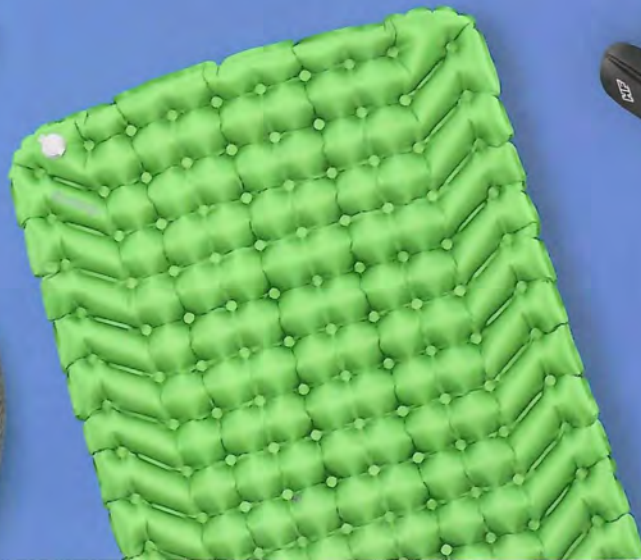

Bestway

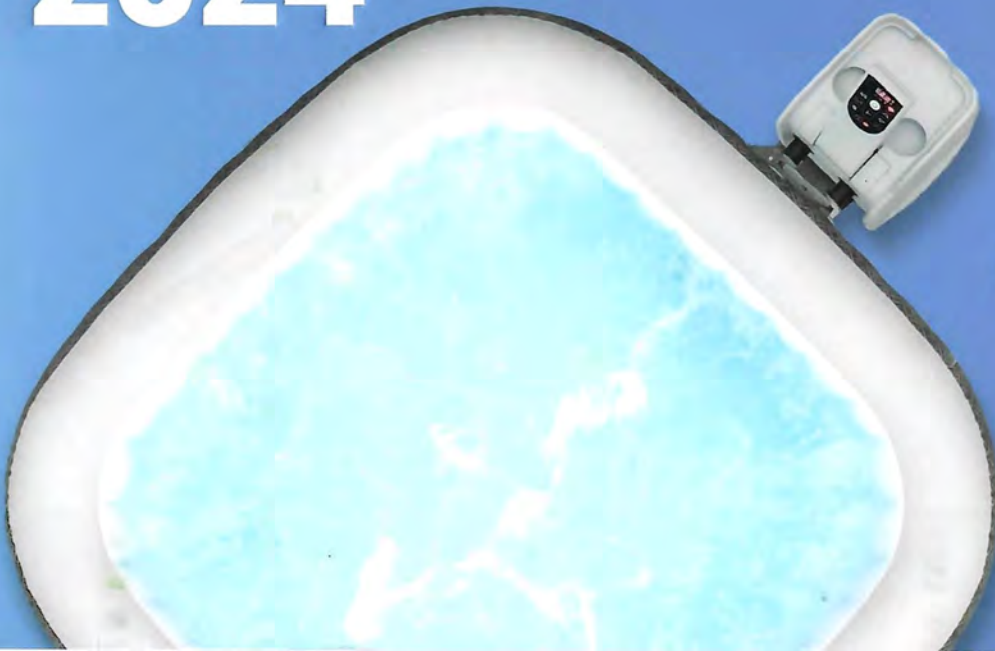

# Bestway

## 2024 CATALOG COLLECTION

Enjoy our extensive collection of products in our six catalogs.

- Above Ground Pools
- Air Mattresses
- Spa
- Summer & License
- Watersports
- Camping Gear\*

Only available for INTL

### Digital Catalogs

Easily access all of our catalogs while on the go. Ask your Sales Rep for the link to our catalog website, and Bestway® products can be right at your fingertips!

- View the latest catalogs
- Quickly flip through and find any product
- Check out product details, photos and even videos

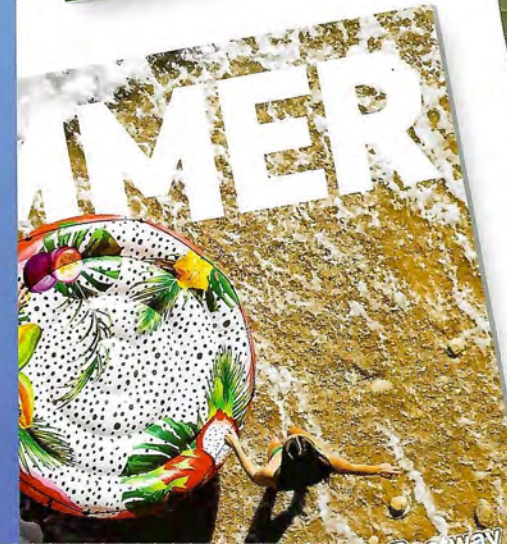
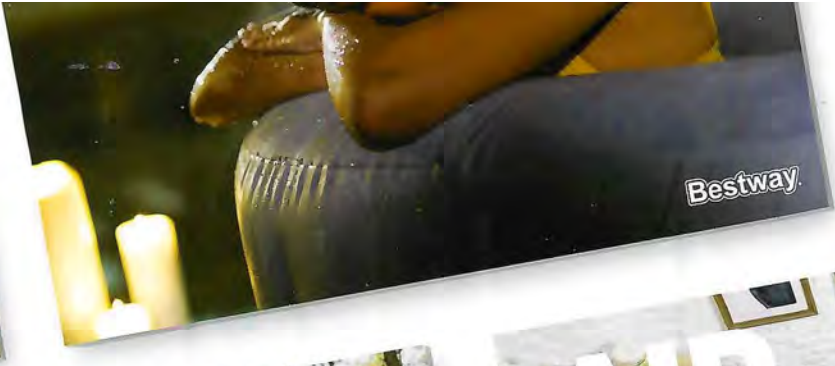



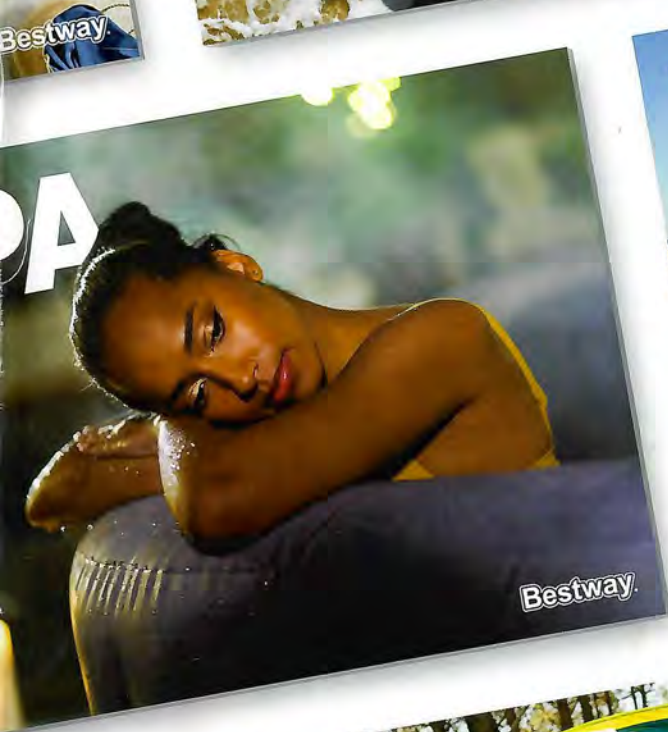





## VISION & MISSION

Since 1994, our vision has been to create fun, memorable experiences for everyone in the world through our innovative, dependable products.

Now, just over 25 years later, **Bestway** has forged a global presence in more than 100 countries by developing an extensive product line and becoming forward thinkers about sustainable business practices. Today, we manufacture and sell more than 1,100 different products within four core categories: above ground pools and portable spas, recreational products, sporting goods, and camping products.

## SERVICE

**Bestway** is committed to customer satisfaction and providing you with the best product solutions. That's why every department in Bestway works closely together - from our technology and quality assurance centers to our laboratories, vertically integrated manufacturing systems and after-sales service centers around the globe.

**Bestway's** advanced online services and regional call centers allow customers to easily resolve issues that arise with their products, offering downloadable manuals, instructional videos, and 24/7 call support.



VERTICALLY  
INTEGRATED



CUSTOMER  
FOCUSED



INNOVATIVE



SUSTAINABLE



CONSUMER  
DRIVEN



FULLY OWNED  
PRODUCTION  
FACILITIES



SERVICE &  
SOLUTIONS



# GLOBAL FACTORIES



JIANGSU



YANCHENG



HAIAN



NANTONG



SHANGHAI



VIETNAM

# AROUND THE WORLD



CHANDLER, U.S.A.  
R&D • SUBSIDIARY



SANTIAGO, CHILE  
SUBSIDIARY



SAN PAULO, BRAZIL  
SUBSIDIARY



HAMBURG, GERMANY  
SUBSIDIARY



NICE, FRANCE  
SUBSIDIARY



MILAN, ITALY  
R&D • SUBSIDIARY



COPENHAGEN, DENMARK  
SUBSIDIARY



WARSAW, POLAND  
SUBSIDIARY



DUBAI, U.A.E.  
SUBSIDIARY



MOSCOW, RUSSIA  
SUBSIDIARY



HONG KONG, CHINA  
R&D • SUBSIDIARY



SHANGHAI, CHINA  
HQ • PRODUCTION



SYDNEY, AUSTRALIA  
SUBSIDIARY



Dear Customer,

We are excited to present our Special Edition Catalog again for the 2024 season!

This collection of items cannot be found in our standard catalogs, and it is only offered to selected partners.

All of these items are designed to offer you something extra, such as new price points, larger assortments of sizes and designs, and exclusive sets.

These products provide the following benefits:

- A broader, more innovative range
- A guaranteed return on investment for your advertising efforts
- The ability to set your own prices due to product differentiation
- An offering of alternative products at attractive prices

These items will be subject to special conditions. If you are interested in the items that you see here, please contact the Bestway team or your Sales Rep for more information.

We look forward to making this the best sales season yet!

The  
Bestway  
Team



# Contents

08

## **TOUGHLITE™**

Sleeping Pads

28

## **AGP**

Above Ground Pools

66

## **AGP ACCESSORIES**

Pool Accessories

72

## **LAY-Z-SPA®**

Premium Inflatable Spas

126

## **HYDRO-FORCE™**

Inflatable Stand-Up Paddleboards

138

## **HYDRO-FORCE™**

Inflatable Kayaks

148

## **SUMMER**

Inflatable Leisure Products







# TOUGHLITE™ SLEEPING PADS

Keep your pack light and enjoy the great outdoors with compact air pads designed with innovative materials to give you extra comfort and warmth. Discover a range of options to fit your outdoors needs – from ultra-thin with cushioned air pockets for avid backpackers to soft, yet supportive foam for campers wanting extra comfort. With Bestway®, there's an air pad to fit every adventure style!

**Frontcountry** - ideal for casual backpackers who enjoy camping in warmer weather and desire high quality, yet affordable outdoor gear.

- WanderLite™
- TerrainLite™

**Backcountry** - for avid backpackers and mountaineers who manage their packs by the ounce and depend on superior performance. Packed weight and size, and insulation value are top priorities for their sleeping pad purchase.

- AlpineLite™
- TerrainPro™

**Basecamp** - ideal for campers or travelers who want a sleeping pad that's comfortable and versatile.

- ComforTrek™
- AdventuRest™

**14** WanderLite™ Regular Rectangular Sleeping Pad

**15** WanderLite™ Large Rectangular Sleeping Pad

**16** AlpineLite™ Insulated Regular Mummy Sleeping Pad

**17** AlpineLite™ Insulated Wide Mummy Sleeping Pad

**18** AdventuRest™ Insulated Regular Rectangular Sleeping Pad

**19** AdventuRest™ Insulated Large Rectangular Sleeping Pad

**20** AdventuRest™ Insulated Queen Sleeping Pad

**22** TerrainLite™ Self-Inflating Regular Mummy Sleeping Pad

**23** TerrainPro™ Self-Inflating Regular Mummy Sleeping Pad

**24** ComforTrek™ Self-Inflating Wide Rectangular Sleeping Pad

**25** ComforTrek™ Luxe Self-Inflating Large Rectangular Sleeping Pad

**26** WanderLite™ Regular Air Pillow

**27** AlpineLite™ Large Air Pillow



SLEEPING PAD

FRONTCOUNTRY

BACKCOUNTRY

BASECAMP



**New**

WANDERLITE™ REGULAR  
RECTANGULAR SLEEPING PAD  
69615

**New**

WANDERLITE™ LARGE  
RECTANGULAR SLEEPING PAD  
69616

**New**

ALPINELITE™ INSULATED  
REGULAR MUMMY  
SLEEPING PAD  
69612

**New**

ALPINELITE™ INSULATED  
WIDE MUMMY  
SLEEPING PAD  
69613

**New**

ADVENTUREST™ INSULATED  
REGULAR RECTANGULAR  
SLEEPING PAD  
69617

**New**

ADVENTUREST™ INSULATED  
LARGE RECTANGULAR  
SLEEPING PAD  
69618

**New**

ADVENTUREST™ INSULATED  
QUEEN SLEEPING PAD  
69619

SIZE

1.88 m x 58.5 cm x 6.5 cm  
(74" x 23" x 2.5")

1.98 m x 71 cm x 6.5 cm  
(78" x 28" x 2.5")

1.83 m x 51 cm x 7.5 cm  
(72" x 20" x 3")

1.83 m x 63.5 cm x 7.5 cm  
(72" x 25" x 3")

1.88 m x 58.5 cm x 7.5 cm  
(74" x 23" x 3")

1.98 m x 71 cm x 7.5 cm  
(78" x 28" x 3")

2.03 m x 1.42 m x 15 cm  
(80" x 56" x 6")

R-VALUE

1.3  
Warm Weather Rated

1.3  
Warm Weather Rated

7.3  
Extreme Weather Rated

7.3  
Extreme Weather Rated

2.7  
Cool Weather Rated

2.7  
Cool Weather Rated

3.5  
Cool Weather Rated

TOP MATERIAL

70D Ripstop Nylon/TPU

70D Ripstop Nylon/TPU

70D Ripstop Nylon/TPU

70D Ripstop Nylon/TPU

70D Ripstop Nylon/TPU

70D Ripstop Nylon/TPU

75D Polyester/TPU

BOTTOM MATERIAL

75D Polyester/TPU

75D Polyester/TPU

70D Ripstop Nylon/ TPU

70D Ripstop Nylon/ TPU

75D Polyester/TPU

75D Polyester/TPU

75D Polyester/TPU

INSULATION MATERIAL

N/A

N/A

2 Layers Aluminum Film

2 Layers Aluminum Film

THERMOLITE® (Fiber)

THERMOLITE® (Fiber)

THERMOLITE® (Fiber)

PUMP

N/A

N/A

Pump Sack

Pump Sack

Pump Sack

Pump Sack

Manual Pump (62086)

PAGES

P. 14

P. 15

P. 16

P. 17

P. 18

P. 19

P. 20



**SELF-INFLATING  
(FOAM CORE  
SLEEPING PAD)**

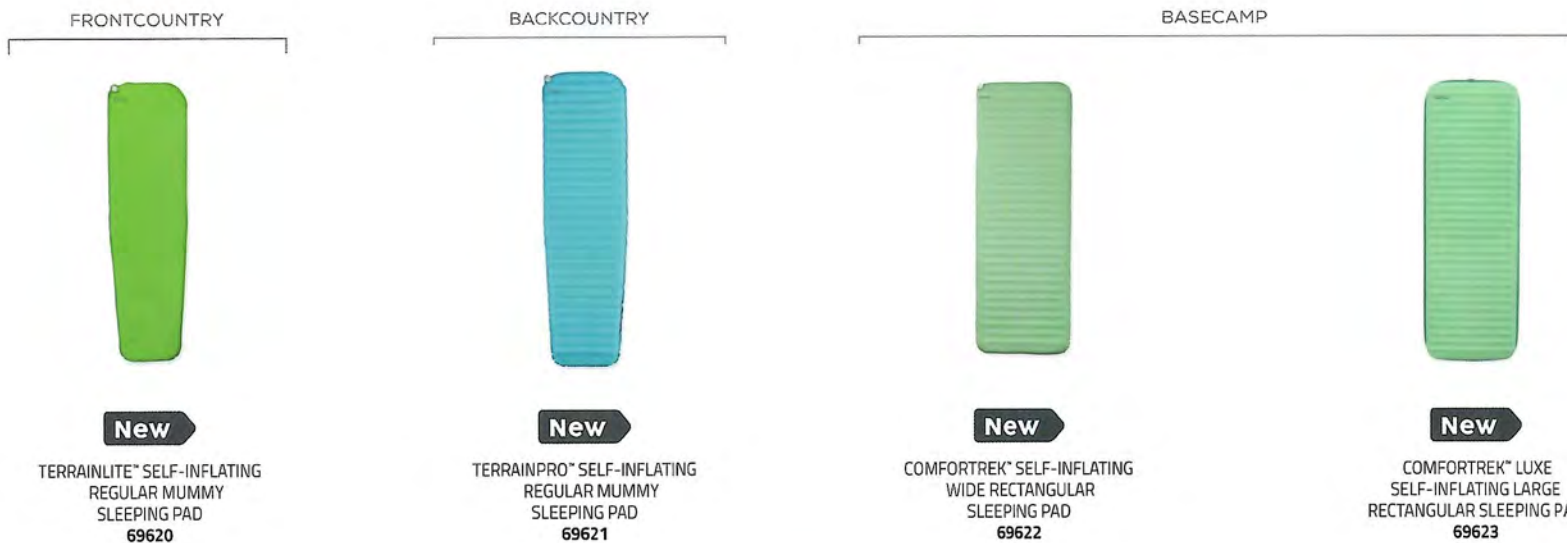

	TERRAINLITE™ SELF-INFLATING REGULAR MUMMY SLEEPING PAD 69620	TERRAINPRO™ SELF-INFLATING REGULAR MUMMY SLEEPING PAD 69621	COMFORTREK™ SELF-INFLATING WIDE RECTANGULAR SLEEPING PAD 69622	COMFORTREK™ LUXE SELF-INFLATING LARGE RECTANGULAR SLEEPING PAD 69623
SIZE	1.83 m x 51 cm x 2.5 cm (72" x 20" x 1")	1.83 m x 51 cm x 5.1 cm (72" x 20" x 2")	1.83 m x 63.5 cm x 7.6 cm (72" x 25" x 3")	1.98 m x 63.5 cm x 10.8 cm (78" x 25" x 4")
R-VALUE	3.8 Cool Weather Rated	4.7 Cold Weather Rated	6.8 Extreme Weather Rated	9.0 Extreme Weather Rated
TOP MATERIAL	70D Ripstop Nylon/TPU	70D Ripstop Nylon/TPU	50D Stretch Knit Polyester/TPU	50D Stretch Knit Polyester/TPU
SIDE MATERIAL	N/A	N/A	N/A	50D Stretch Knit Polyester/TPU
BOTTOM MATERIAL	75D Polyester/TPU	70D Ripstop Nylon/ TPU	75D Polyester/TPU	75D Polyester/TPU
INSULATION MATERIAL	PU Foam	PU Foam	PU Foam	PU Foam
PUMP	N/A	N/A	N/A	N/A
PAGES	P. 22	P. 23	P. 24	P. 25



ACCESSORIES

FRONTCOUNTRY



**New**

WANDERLITE™ REGULAR  
AIR PILLOW  
69624

42 cm x 30 cm x 12 cm  
(16.5" x 11.5" x 4.5")

BACKCOUNTRY



**New**

ALPINELITE™ LARGE  
AIR PILLOW  
69625

49.5 cm x 28 cm x 12 cm  
(19.5" x 11" x 4.5")

SIZE

TOP  
MATERIAL

SIDE  
MATERIAL

BOTTOM  
MATERIAL

REMOVABLE  
COVER

PAGES

50D Stretch Knit Polyester/TPU

50D Stretch Knit Polyester/TPU

50D Stretch Knit Polyester/TPU

N/A

P. 26

Flexible 75D Stretch Knit Polyester/TPU

Flexible 75D Stretch Knit Polyester/TPU

Flexible 75D Stretch Knit Polyester/TPU

YES

P. 27











Frontcountry

# WanderLite™ Regular RECTANGULAR SLEEPING PAD

**69615**

NEW!

- Fits a regular sized sleeping bag
- R Value of 1.3, ideal for warm weather
- Pad Weight: 549 g (1 lb 3 oz)
- Compact, packed size of 10.5 cm x 10.5 cm x 19.5 cm / 4" x 4" x 7.5" to easily fit in your pack
- Puncture-resistant ToughLite™ material and sporty, durable 70D ripstop nylon fabric
- CrossWing™ design features inclined air pockets on both sides to prevent rolling and keep you comfortable
- Low profile valve has quick inflation and deflation modes and allows for easy pressure adjustment
- Full color box

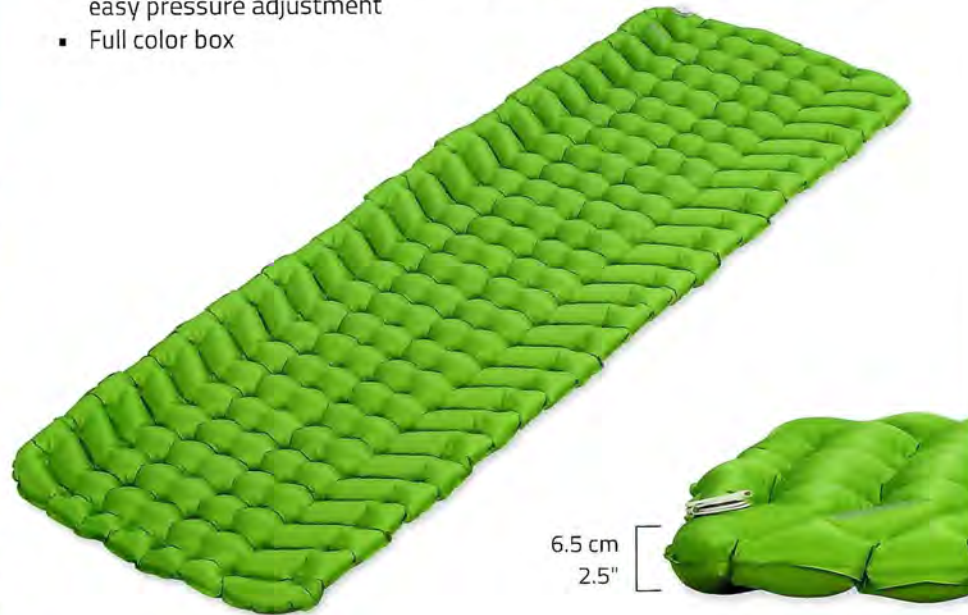

## HIGHLIGHTS



549 g / 1 lb 3 oz  
Pad Weight



Puncture-Resistant  
ToughLite™



R Value: Warm Weather  
Rated

Item No.	Size	Air Pump	Pack	kg (Lbs)
69615	1.88 m x 58.5 cm x 6.5 cm / 74" x 23" x 2.5"	N/A	8 PCS	5.8 (12.8)

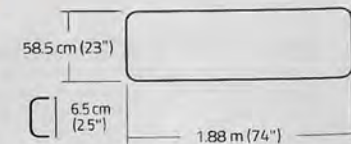





Frontcountry

# WanderLite™ Large RECTANGULAR SLEEPING PAD

69616

NEW!

- Fits larger sized sleeping bag
- R Value of 1.3, ideal for warm weather
- Pad Weight: 686 g (1 lb 8 oz)
- Compact, packed size of 10 cm x 10 cm x 23 cm / 4" x 4" x 9" easily fits in your pack
- Puncture-resistant ToughLite™ material and sporty, durable 70D ripstop nylon fabric
- CrossWing™ design features inclined air pockets on both sides to prevent rolling and keep you comfortable
- Low profile valve has quick inflation and deflation modes and allows for easy pressure adjustment
- Full color box

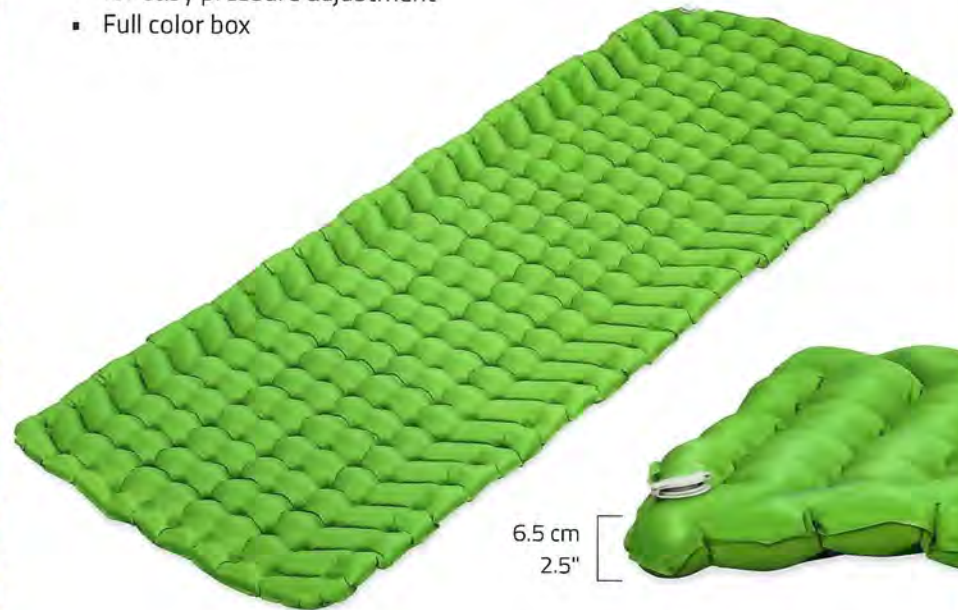

6.5 cm  
2.5"

## HIGHLIGHTS



686 g / 1 lb 8 oz  
Pad Weight



Puncture-Resistant  
ToughLite™



R Value: Warm Weather  
Rated

Item No.	Size	Air Pump	Pack	kg (Lbs)
69616	1.98 m x 71 cm x 6.5 cm / 78" x 28" x 2.5"	N/A	8 PCS	6.9 (15.3)

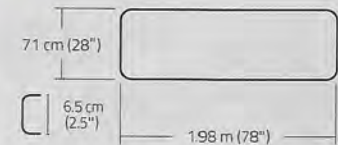





Backcountry

# AlpineLite™ Insulated Regular MUMMY SLEEPING PAD

**69612**

NEW!

- Fits regular mummy sleeping bag
- R Value of 7.3, ideal for extreme weather
- Pad Weight: 657 g (1 lb 7 oz)
- Compact, packed size of 10 cm x 10 cm x 24 cm / 4" x 4" x 9.5" to easily fit in your pack
- Puncture-resistant ToughLite™ material and sporty, durable 70D ripstop nylon fabric
- ThermaZone™ features two layers of aluminized film for superior insulation
- Pump sack is durable and lightweight
- Low profile valve has quick inflation and deflation modes and allows for easy pressure adjustment
- Full color box

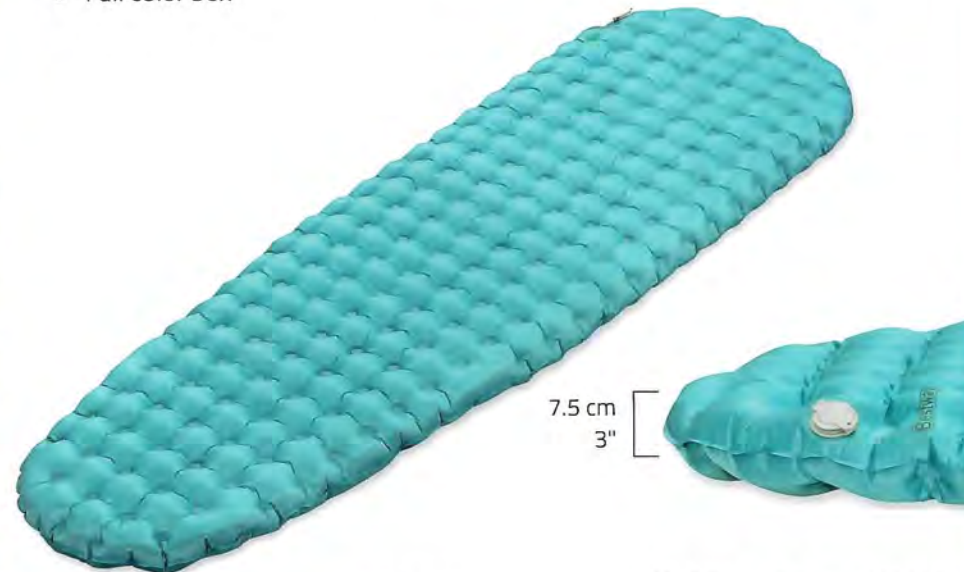

Item No.	Size	Air Pump	Pack	kg (Lbs)
69612	1.83 m x 51 cm x 7.5 cm / 72" x 20" x 3"	Pump Sack	6 PCS	5.7 (12.5)

## HIGHLIGHTS



657 g / 1 lb 7 oz  
Pad Weight



Puncture-Resistant  
ToughLite™



R Value: Extreme  
Weather Rated

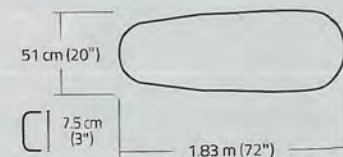





Backcountry

# AlpineLite™ Insulated Wide MUMMY SLEEPING PAD

**69613**

NEW!

- Fits a larger mummy sleeping bag
- R Value of 7.3, ideal for extreme weather
- Pad Weight: 764 g (1 lb 11 oz)
- Compact, packed size of 11.5 cm x 11.5 cm x 27 cm / 4.5" x 4.5" x 10.5"
- Puncture-resistant ToughLite™ material and sporty, durable 70D ripstop nylon fabric
- ThermaZone™ features two layers of aluminized film for superior insulation
- Pump sack is durable and lightweight
- Low profile valve has quick inflation and deflation modes and allows for easy pressure adjustment
- Full color box



Item No.	Size	Air Pump	Pack	kg (Lbs)
69613	1.83 m x 63.5 cm x 7.5 cm / 72" x 25" x 3"	Pump Sack	6 PCS	6.6 (14.6)

## HIGHLIGHTS



764 g / 1 lb 11 oz  
Pad Weight



Puncture-Resistant  
ToughLite™



R Value: Extreme  
Weather Rated

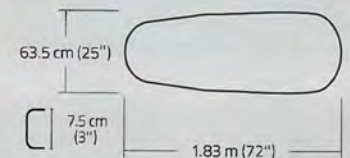





Basecamp

# AdventuRest™ Insulated Regular RECTANGULAR SLEEPING PAD

69617

NEW!

- Fits a regular sleeping bag
- R Value of 2.7, ideal for cool weather
- Pad Weight: 798 g (1 lb 12 oz)
- Compact, packed size of 12.5 cm x 12.5 cm x 23 cm / 5" x 5" x 9"
- Puncture-resistant ToughLite™ material and sporty, durable 70D ripstop nylon fabric
- THERMOLITE® insulation provides lightweight warmth and quiet comfort
- I-beam design keeps you centered and in place
- Pump sack is durable and lightweight
- Low profile valve has quick inflation and deflation modes and allows for easy pressure adjustment
- Full color box

**THERMOLITE®**

THERMOLITE® is a trademark of The LYCRA company.



7.5 cm  
3"

Item No.	Size	Air Pump	Pack	kg (Lbs)
69617	1.88 m x 58.5 cm x 7.5 cm / 74" x 23" x 3"	Pump Sack	6 PCS	6.9 (15.2)

## HIGHLIGHTS



798 g / 1 lbs 12 oz  
Pad Weight



Puncture-Resistant  
ToughLite™



R Value: Cool Weather  
Rated

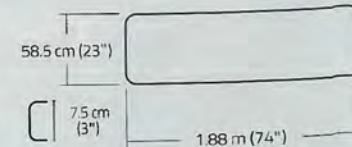

58.5 cm (23")

7.5 cm (3")

1.88 m (74")





Basecamp

# AdventuRest™ Insulated Large RECTANGULAR SLEEPING PAD

69618

NEW!

- Fits a larger sleeping bag
- R Value of 2.7, ideal for cool weather
- Pad Weight: 1.03 kg (2 lbs 4 oz)
- Compact, packed size of 14 cm x 14 cm x 27.5 cm / 5.5" x 5.5" x 10.5"
- Puncture-resistant ToughLite™ material and sporty, durable 70D ripstop nylon fabric
- THERMOLITE® insulation provides lightweight warmth and quiet comfort
- I-beam design keeps you centered and in place
- Pump sack is durable and lightweight
- Low profile valve has quick inflation and deflation modes and allows for easy pressure adjustment
- Full color box

**THERMOLITE®**

THERMOLITE® is a trademark of The LYCRA company.



Item No.	Size	Air Pump	Pack	kg (Lbs)
69618	1.98 m x 71 cm x 7.5 cm / 78" x 28" x 3"	Pump Sack	6 PCS	8.8 (19.3)

## HIGHLIGHTS



1.03 kg / 2 lbs 4 oz  
Pad Weight



Puncture-Resistant  
ToughLite™

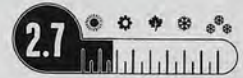

R Value: Cool Weather  
Rated

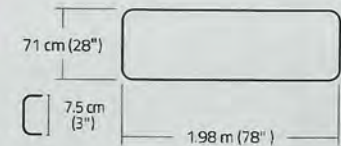



# SLEEPING PADS



**AdventuRest™ INSULATED  
QUEEN SLEEPING PAD**

69619

NEW!



# HIGHLIGHTS



2.15 kg / 4 lbs 12 oz  
Pad Weight



Puncture-Resistant  
ToughLite™



R Value: Cool Weather  
Rated

- Fits under one or more sleeping bags
- R Value of 3.5 for cool weather
- Pad Weight: 2.15 kg (4 lbs 12 oz)
- Packed size of 19 cm x 19 cm x 45 cm / 7.5" x 7.5" x 17.5"
- Puncture-resistant ToughLite™ material and durable 75D polyester fabric
- THERMOLITE® insulation provides lightweight warmth and quiet comfort
- I-beam design keeps you centered and in place with 15 cm height to keep you away from the ground
- Convenient, manual pump makes it easier and faster to inflate the pad
- Low profile valve has quick inflation and deflation modes and allows for easy pressure adjustment
- Full color box

**THERMOLITE®**

THERMOLITE® is a trademark of The LYCRA company.



Item No.	Size	Air Pump	Pack	kg (Lbs)
69619	2.03 m x 1.42 m x 15 cm / 80" x 56" x 6"	Manual Pump (62086)	4 PCS	13.7 (30.1)



## TOUGHLITE™ MATERIAL

Puncture-resistant material with durable 75D polyester fabric

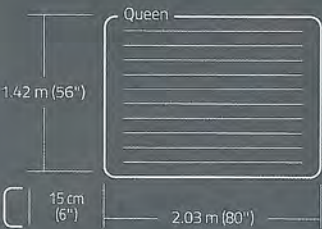

15 cm  
6"







Frontcountry

# TerrainLite™ Self-Inflating Regular MUMMY SLEEPING PAD

**69620**

NEW!

- Fits a regular mummy sleeping bag
- R Value of 3.8, ideal for cool weather
- Pad Weight: 800 g (1 lb 12 oz)
- Packed size of 14 cm x 54 cm / 5.5" x 21"
- Puncture-resistant ToughLite™ material and sporty, durable 70D ripstop nylon fabric
- Foam pad self-inflates once valve is opened, expanding to 2.5 cm thickness
- Low profile valve has quick inflation and deflation modes and allows for easy pressure adjustment
- Carry bag with hang tag



## HIGHLIGHTS



800 g / 1 lb 12 oz  
Pad Weight



Fits a Regular  
Mummy Sleeping Bag



R Value: Cool Weather  
Rated

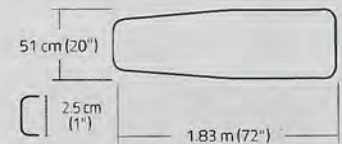

Item No.	Size	Air Pump	Pack	kg (Lbs)
69620	1.83 m x 51 cm x 2.5 cm / 72" x 20" x 1"	N/A	4 PCS	4.1 (9.0)





Backcountry

# TerrainPro™ Self-Inflating Regular MUMMY SLEEPING PAD

**69621**

NEW!

- Fits a regular mummy sleeping bag
- R Value of 4.7, ideal for cold weather
- Pad Weight: 924 g (2 lbs 1 oz)
- Packed size of 15 cm x 54 cm / 6" x 21"
- Puncture-resistant ToughLite™ material and sporty, durable 70D ripstop nylon fabric
- Foam pad self-inflates once valve is opened, expanding to 5.1 cm thickness
- I-shape foam core improves warmth and comfort while reducing the pad's weight
- Low profile valve has quick inflation and deflation modes and allows for easy pressure adjustment
- Carry bag with hang tag



Item No.	Size	Air Pump	Pack	kg (Lbs)
69621	1.83 m x 51 cm x 5.1 cm / 72" x 20" x 2"	N/A	4 PCS	4.7 (10.3)

## HIGHLIGHTS



924 g / 2 lb 1 oz  
Pad Weight



Fits a Regular  
Mummy Sleeping Bag



R Value: Cold Weather  
Rated

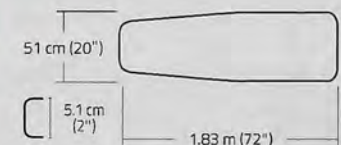





Basecamp

# ComforTrek™ Self-Inflating Wide RECTANGULAR SLEEPING PAD

**69622**

NEW!

- Fits larger sleeping bag
- R Value of 6.8, ideal for extreme weather
- Pad Weight: 1.63 kg (3 lbs 9 oz)
- Packed size of 21 cm x 66 cm / 8" x 26"
- Puncture-resistant ToughLite™ material and soft, yet flexible 50D stretch knit polyester fabric
- Foam pad will self-inflate once valve is opened, expanding to 7.6 cm thickness
- I-shape foam core provides thermal insulation and comfort while reducing the pad's weight
- Exclusive SpinSeal™ valve switches air inflow and outflow with rotating inner closure
- Carry bag with hang tag



Item No.	Size	Air Pump	Pack	kg (Lbs)
69622	1.83 m x 63.5 cm x 7.6 cm / 72" x 25" x 3"	N/A	4 PCS	8.2 (18.1)

## HIGHLIGHTS



1.63 kg / 3 lbs 9 oz  
Pad Weight



Fits a Wide Rectangular  
Sleeping Bag



R Value: Extreme Weather  
Rated

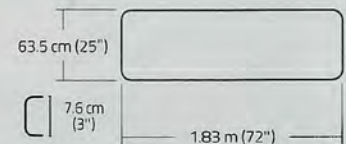





Basecamp

# ComforTrek™ Luxe Self-Inflating Large RECTANGULAR SLEEPING PAD

**69623**

NEW!

- Fits larger sleeping bag
- R Value of 9.0, ideal for extreme weather
- Pad Weight: 2.40 kg (5 lbs 5 oz)
- Packed size of 26 cm x 66 cm / 10" x 26"
- Puncture-resistant ToughLite™ material and soft, yet flexible 50D stretch knit polyester fabric
- Foam pad self-inflates once valve is opened, expanding to 10.8 cm thickness for extra comfort
- I-shape foam core provides thermal insulation and comfort while reducing the pad's weight
- Exclusive SpinSeal™ valve switches air inflow and outflow with rotating inner closure
- Carry bag with hang tag



Item No.	Size	Air Pump	Pack	kg (Lbs)
69623	1.98 m x 63.5 cm x 10.8 cm / 78" x 25" x 4"	N/A	4 PCS	12.0 (26.4)

## HIGHLIGHTS



2.40 kg / 5 lbs 5 oz  
Pad Weight



Fits a Wide Rectangular  
Sleeping Bag



R Value: Extreme Weather  
Rated

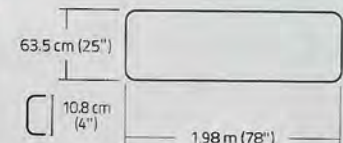





Frontcountry

# WanderLite™ Regular AIR PILLOW

**69624**

NEW!

- Regular size pillow
- Pillow Weight: 96 g (3.4 oz)
- Compact, packed size of 6.5 cm x 10 cm / 2.5" x 4"
- Puncture-resistant ToughLite™ material and soft 50D stretch knit polyester fabric with a gentle, curved design for neck support
- Low profile valve has quick inflation and deflation modes and allows for easy pressure adjustment
- Carry bag with header card



## HIGHLIGHTS



96 g / 3.4 oz  
Pillow Weight



Puncture-Resistant  
ToughLite™

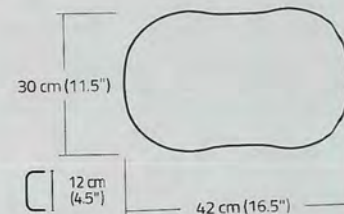

Item No.	Size	Air Pump	Pack	kg (Lbs)
69624	42 cm x 30 cm x 12 cm / 16.5" x 11.5" x 4.5"	N/A	40 PCS	4.5 (9.8)





Backcountry

# AlpineLite™ Large AIR PILLOW

**69625**

NEW!

- Deluxe, large-sized pillow
- Pillow Weight: 182 g (6.4 oz)
- Packed size of 9 cm x 12 cm / 3.5" x 4.5"
- Puncture-resistant ToughLite™ material and soft, flexible 75D stretch knit polyester fabric
- Outer fabric covering can be removed for cleaning
- Low profile valve has quick inflation and deflation modes and allows for easy pressure adjustment
- Carry bag with header card



Item No.	Size	Air Pump	Pack	kg (Lbs)
69625	49.5 cm x 28 cm x 12 cm / 19.5" x 11" x 4.5"	N/A	40 PCS	8.3 (18.2)

## HIGHLIGHTS



182 g / 6.4 oz  
Pillow Weight



Puncture-Resistant  
ToughLite™

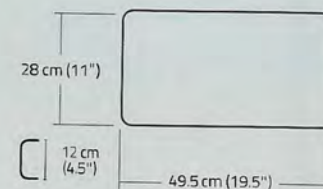







# ABOVE GROUND POOLS

When people think of Bestway® pools, they think of summer memories, good quality and reliability. We are always enhancing our overall line to improve durability and longevity. This line encompasses the best and most innovative pools selected for your market.

**30** Fast Set™  
Pools

**34** Steel Pro®  
Pools

**42** Steel Pro MAX™  
Pools

**56** Power Steel®  
Pools

**62** Power Steel® Swim  
Vista Series™ II Pools



# FAST SET™

## Fast and simple to assemble!

Just select a level surface, inflate the top ring, fill the pool with water and you'll be splashing around in no time! No tools required for a Bestway® Fast Set Pool!



### TECHNOLOGY HIGHLIGHTS - PRODUCT DESIGN

#### DuraPlus™

3-layer puncture resistant liner material

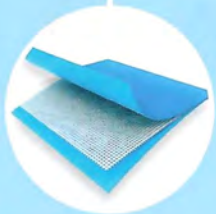

#### Self-Supporting

Inflatable top ring



#### 1-2-3 Setup

Easy to assemble





P R O D U C T M A T R I X - P O O L R A N G E

	1.83 m x 51 cm - 6' x 20"	Fast Set™ Pool	<i>Refer to International Catalog</i>
	2.44 m x 61 cm - 8' x 24"	Fast Set™ Pool	<i>Refer to International Catalog</i>
	3.05 m x 66 cm - 10' x 26"	Fast Set™ Pool	<i>Refer to International Catalog</i>
	3.05 m x 76 cm - 10' x 30"	Fast Set™ Pool	PG. 32
	3.66 m x 76 cm - 12' x 30"	Fast Set™ Pool	<i>Refer to International Catalog</i>
	3.66 m x 76 cm - 12' x 30"	Fast Set™ Pool	<i>Refer to International Catalog</i>
	3.96 m x 84 cm - 13' x 33"	Fast Set™ Pool	<i>Refer to International Catalog</i>
	4.57 m x 84 cm - 15' x 33"	Fast Set™ Pool	<i>Refer to International Catalog</i>
	4.57 m x 1.07 m - 15' x 42"	Fast Set™ Pool	<i>Refer to International Catalog</i>
	4.57 m x 1.22 m - 15' x 48"	Fast Set™ Pool	PG. 32



# Fast Set™ Pools

# ABOVE GROUND POOLS



**Bestway.**  
Fast Set™



10 ft. x 30 in.









Water Capacity (80%): 1,004 gal. (3,800 L)

### 10 ft. x 30 in. / 3.05 m x 76 cm

ITEM	REGION	PACK	LBS (KG)	 FILTER PUMP	 VOLTAGE	 CARTRIDGE
57307	North America	1	18.2 (8.2)			
57307	Oceania	1	18.2 (8.2)			
57266	Europe	1	18.2 (8.2)			
57269	Oceania	1	23.0 (10.4)	58381 (330 gal. /1,249 L)	220-240V	58093, TYPE: I
57270	Europe	1	23.8 (10.8)	58381 (330 gal. /1,249 L)	220-240V	58093, TYPE: I
57270	Asia, Africa & Latin America	1	22.1 (10.0)	58381 (330 gal. /1,249 L)	220-240V	58093, TYPE: I
57269	Asia, Africa & Latin America	1	23.6 (10.7)	58511 (330 gal. /1,249 L)	110-120V	58093, TYPE: I

Water Capacity (80%): 3,648 gal. (13,807 L)

### 15 ft. x 48 in. / 4.57 m x 1.22 m

ITEM	REGION	PACK	LBS (KG)	 FILTER PUMP	 VOLTAGE	 CARTRIDGE	 LADDER
57289	Europe	1	99.6 (45.2)	58386 (800 gal. /3,028 L)	220-240V	58094, TYPE: II	58331
57289	Asia, Africa & Latin America	1	93.1 (42.2)	58386 (800 gal. /3,028 L)	220-240V	58094, TYPE: II	58336

### Features & Technologies

#### Build

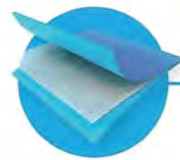
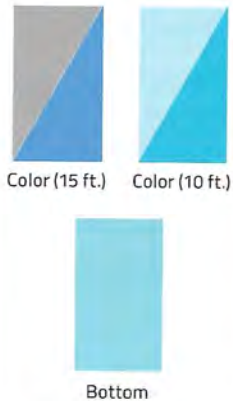
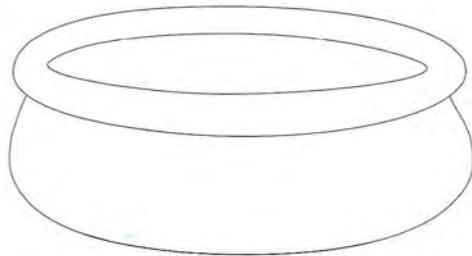

DuraPlus<sup>™</sup> Construction

#### Convenience



Drain Valve



Super compact  
Easy to transport



No Tools  
Required



Easy  
to store



Packaging:  
10 ft. x 30 in. = Full Color Box  
15 ft. x 48 in. = Sturdy Cardboard  
Box with Pictures



# STEEL PRO<sup>®</sup>

Easy to assemble and very affordable, with a strong, steel frame.

You get a lot of pool for your money with a Bestway<sup>®</sup> Steel Pro Pool.



## TECHNOLOGY HIGHLIGHTS - PRODUCT DESIGN

**FrameLink System™**  
Corrosion prevention



**DuraPlus™**  
3-layer puncture resistant liner material

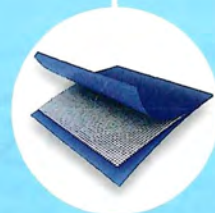



# P R O D U C T M A T R I X - P O O L R A N G E

	3.05 m x 66 cm 10' x 26"	Steel Pro® Round Pool	PG. 36
	3.05 m x 76 cm 10' x 30"	Steel Pro® Round Pool	PG. 38
	3.66 m x 76 cm 12' x 30"	Steel Pro® Round Pool	PG. 38
	2.21 m x 1.50 m x 43 cm 7'3" x 59" x 17"	Steel Pro® Rectangular Pool	<i>Refer to International catalog</i>
	2.59 m x 1.70 m x 61 cm 8'6" x 67" x 24"	Steel Pro® Rectangular Pool	<i>Refer to International catalog</i>
	3.00 m x 2.01 m x 66 cm 9'10" x 67" x 26"	Steel Pro® Rectangular Pool	<i>Refer to International catalog</i>
	3.66 m x 2.01 m x 66 cm 12' x 67" x 26"	Steel Pro® Rectangular Pool	PG. 40
	4.00 m x 2.11 m x 81 cm 13'1" x 6'11" x 32"	Steel Pro® Rectangular Pool	<i>Refer to International catalog</i>



# Steel Pro® Round Pools

ABOVE GROUND POOLS







Water Capacity (90%): 1,073 gal. (4,062 L)

**New Design**

**10 ft. x 26 in. / 3.05 m x 66 cm**

ITEM	REGION	PACK	LBS (KG)
56986	North America	1	35.0 (15.9)
56986	Oceania	1	35.0 (15.9)
56985	Europe	1	34.9 (15.8)

**Features & Technologies**

FrameLink System™



Build

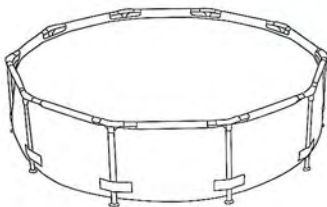

Pattern



Bottom

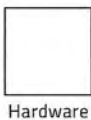

Hardware

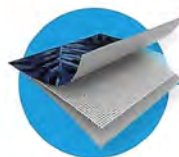

DuraPlus Construction

Convenience



Drain Valve



Super compact  
Easy to transport



No Tools  
Required



Easy  
to store



Packaging:  
Full Color Box



# Steel Pro® Round Pools

ABOVE GROUND POOLS



## Features & Technologies



FrameLink System™

Color



Bottom



Hardware

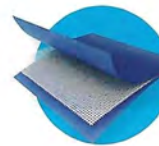

DuraPlus™ Construction

### Convenience



Drain Valve



Super compact  
Easy to transport



No Tools  
Required



Easy  
to store

### Build

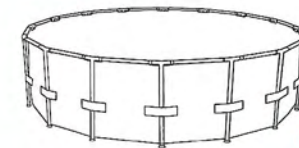

### Packaging

Packaging:  
Full Color Box













Water Capacity (90%): 1,236 gal. (4,678 L)

### 10 ft. x 30 in. / 3.05 m x 76 cm

ITEM	REGION	PACK	LBS (KG)	 FILTER PUMP	 VOLTAGE	 CARTRIDGE
56677	Europe	1	37.3 (16.9)			
56678	Oceania	1	42.7 (19.4)	58381 (330 gal. /1,249 L)	220-240V	58093, TYPE: I
56679	Europe	1	42.0 (19.1)	58381 (330 gal. /1,249 L)	220-240V	58093, TYPE: I
56679	Asia, Africa & Latin America	1	41.0 (18.6)	58381 (330 gal. /1,249 L)	220-240V	58093, TYPE: I
56678	Asia, Africa & Latin America	1	42.0 (19.1)	58511 (330 gal. /1,249 L)	110-120V	58093, TYPE: I

Water Capacity (90%): 1,710 gal. (6,473 L)

### 12 ft. x 30 in. / 3.66 m x 76 cm

ITEM	REGION	PACK	LBS (KG)	 FILTER PUMP	 VOLTAGE	 CARTRIDGE
56706	Europe	1	46.3 (21.0)			
56680	Oceania	1	51.7 (23.5)	58381 (330 gal. /1,249 L)	220-240V	58093, TYPE: I
56681	Europe	1	51.1 (23.2)	58381 (330 gal. /1,249 L)	220-240V	58093, TYPE: I
56681	Asia, Africa & Latin America	1	50.0 (22.7)	58381 (330 gal. /1,249 L)	220-240V	58093, TYPE: I
56680	Asia, Africa & Latin America	1	51.0 (23.1)	58511 (330 gal. /1,249 L)	110-120V	58093, TYPE: I



# Steel Pro® Rectangular Pools

## ABOVE GROUND POOLS







Water Capacity (90%): 1,056 gal. (4,000 L) **New**

**12 ft. x 6 ft. 7 in. x 26 in. / 3.66 m x 2.01 m x 66 cm**



ITEM	REGION	PACK	LBS (KG)	FILTER PUMP	VOLTAGE	CARTRIDGE
561FS	North America	1	49.2 (22.3)			
561FS	Oceania	1	49.2 (22.3)			
561FT	Europe	1	49.2 (22.3)			
561FT	Asia, Africa & Latin America	1	49.2 (22.3)			
561FU	North America	1	53.2 (24.2)	58511 (330 gal. /1,249 L)	110-120V	58093, TYPE: I
561FU	Oceania	1	53.2 (24.2)	58381 (330 gal. /1,249 L)	220-240V	58093, TYPE: I
561FV	Europe	1	53.6 (24.3)	58381 (330 gal. /1,249 L)	220-240V	58093, TYPE: I
561FV	Asia, Africa & Latin America	1	52.5 (23.8)	58381 (330 gal. /1,249 L)	220-240V	58093, TYPE: I
561FU	Asia, Africa & Latin America	1	52.5 (23.8)	58511 (330 gal. /1,249 L)	110-120V	58093, TYPE: I

**Features & Technologies**



Build

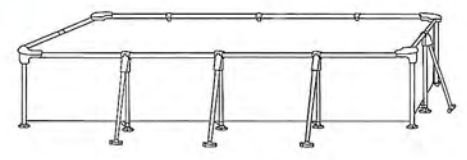

Pattern



Bottom



Hardware

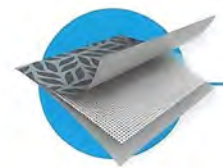

**DuraPlus™ Construction**

**Convenience**



Drain Valve



Super compact  
Easy to transport



No Tools  
Required



Easy to store



Packaging:  
Full Color Box



# STEEL PRO MAX™ POOLS

These pools take fun, durability and reliability to the MAX.

The Steel Pro MAX™ above ground pool is designed with a steel frame for increased strength and durability. With the FrameLink System™ or ClickConnect System™ included, the Steel Pro MAX is an unbelievably amazing pool that is long-lasting!



## TECHNOLOGY HIGHLIGHTS - PRODUCT DESIGN

### FrameLink System™

Corrosion prevention



### ClickConnect System™

Quick-click system and rust prevention



### DuraPlus™

3-layer puncture resistant liner material

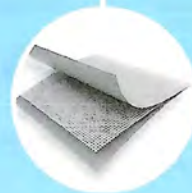





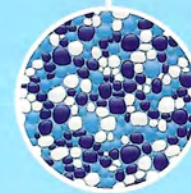



















### Prismatic Stone™

Inner liner





P R O D U C T M A T R I X - P O O L R A N G E

	3.05 m x 76 cm 10' x 30"	Steel Pro MAX™ Pool	Refer to International Catalog		4.27 m x 1.07 m 14' x 42"	Steel Pro MAX™ Pool	PG. 48
	3.66 m x 76 cm 12' x 30"	Steel Pro MAX™ Pool	Refer to International Catalog		4.27 m x 1.22 m 14' x 48"	Steel Pro MAX™ Pool	Refer to International Catalog
	3.66 m x 1.00 m 12' x 39.5"	Steel Pro MAX™ Pool	Refer to International Catalog		4.27 m x 1.22 m 14' x 48"	Steel Pro MAX™ Pool	PG. 52
	3.66 m x 1.00 m 12' x 39.5"	Steel Pro MAX™ Pool	PG. 44		4.57 m x 1.07 m 15' x 42"	Steel Pro MAX™ Pool	PG. 54
	3.66 m x 1.00 m 12' x 39.5"	Steel Pro MAX™ Pool	PG. 48		4.57 m x 1.07 m 15' x 42"	Steel Pro MAX™ Pool	Refer to International Catalog
	3.66 m x 1.00 m 12' x 39.5"	Steel Pro MAX™ Pool	PG. 46		4.57 m x 1.22 m 15' x 48"	Steel Pro MAX™ Pool	Refer to International Catalog
	3.66 m x 1.22 m 12' x 48"	Steel Pro MAX™ Pool	Refer to International Catalog		4.88 m x 1.22 m 16' x 48"	Steel Pro MAX™ Pool	Refer to International Catalog
	3.66 m x 1.22 m 12' x 48"	Steel Pro MAX™ Pool	PG. 50		4.88 m x 1.22 m 16' x 48"	Steel Pro MAX™ Pool	PG. 52
	3.96 m x 1.07 m 13' x 42"	Steel Pro MAX™ Pool	Refer to International Catalog		5.49 m x 1.22 m 18' x 48"	Steel Pro MAX™ Pool	Refer to International Catalog
	3.96 m x 1.22 m 13' x 48"	Steel Pro MAX™ Pool	Refer to International Catalog		5.49 m x 1.22 m 18' x 48"	Steel Pro MAX™ Pool	PG. 52
	4.27 m x 84 cm 14' x 33"	Steel Pro MAX™ Pool	Refer to International Catalog		5.49 m x 1.32 m 18' x 52"	Steel Pro MAX™ Pool	Refer to International Catalog
	4.27 m x 1.07 m 14' x 42"	Steel Pro MAX™ Pool	Refer to International Catalog		6.10 m x 1.32 m 20' x 52"	Steel Pro MAX™ Pool	Refer to International Catalog



# Steel Pro MAX™ Pools

ABOVE GROUND POOLS



**Bestway**  
Steel Pro  
**MAX**





Water Capacity (90%): 2,417 gal. (9,150 L)

## 12 ft. x 39.5 in. / 3.66 m x 1.00 m

ITEM	REGION	PACK	LBS (KG)	FILTER PUMP	VOLTAGE	CARTRIDGE	LADDER
56709	Europe	1	83.8 (38.0)	58383 (530 gal. /2,006 L)	220-240V	58094, TYPE: II	58330
56709	Asia, Africa & Latin America	1	81.1 (36.8)	58383 (530 gal. /2,006 L)	220-240V	58094, TYPE: II	58335
56731	Asia, Africa & Latin America	1	81.1 (36.8)	58384 (530 gal. /2,006 L)	110-120V	58012, TYPE: III - A/C	58335

### Features & Technologies

#### FrameLink System™



#### Build

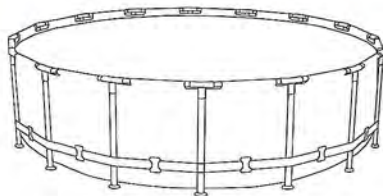

Pattern



Bottom



Hardware

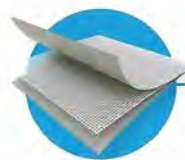

#### DuraPlus™ Construction

#### Convenience



Drain Valve



Corrosion Resistant



3-Ply PVC



No Tools Required



Packaging: Full Color Box



# Steel Pro MAX™ Pools

# ABOVE GROUND POOLS







Water Capacity (90%): 2,417 gal. (9,150 L)

## 12 ft. x 39.5 in. / 3.66 m x 1.00 m



ITEM	REGION	PACK	LBS (KG)	FILTER PUMP	VOLTAGE	CARTRIDGE	LADDER	ENCLOSURE
5619N	Europe	1	117.3 (53.2)	58383 (530 gal. / 2,006 L)	220-240V	58094, TYPE: II	58330	✓

### Features & Technologies

FrameLink System™



Build

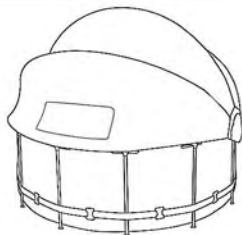

Color



Bottom



Hardware

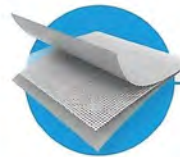

DuraPlus™ Construction

Convenience



Drain Valve



Corrosion Resistant



3-Ply PVC



No Tools Required



Packaging: Full Color Box



# Steel Pro MAX™ Pools

ABOVE GROUND POOLS



**Bestway**  
Steel Pro  
**MAX**





Water Capacity (90%): 2,417 gal. (9,150 L)

### 12 ft. x 39.5 in. / 3.66 m x 1.00 m

ITEM	REGION	PACK	LBS (KG)	FILTER PUMP	VOLTAGE	CARTRIDGE	LADDER
5614X	Europe	1	83.8 (38.0)	58383 (530 gal. /2,006 L)	220-240V	58094, TYPE: II	58330
5614X	Asia, Africa & Latin America	1	81.1 (36.8)	58383 (530 gal. /2,006 L)	220-240V	58094, TYPE: II	58335

Water Capacity (90%): 3,440 gal. (13,030 L)

### 14 ft. x 42 in. / 4.27 m x 1.07 m

ITEM	REGION	PACK	LBS (KG)	FILTER PUMP	VOLTAGE	CARTRIDGE	COVER	LADDER
5614Z	Europe	1	116.3 (52.7)	58386 (800 gal. /3,028 L)	220-240V	58094, TYPE: II	58248	58330
5614Z	Asia, Africa & Latin America	1	112.2 (50.9)	58386 (800 gal. /3,028 L)	220-240V	58094, TYPE: II	58248	58335

**Features & Technologies**

**ClickConnect System™**  
5614Z



**FrameLink System™**  
5614X

**Build**

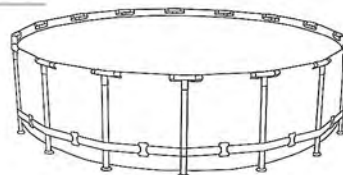

Pattern



Bottom



Hardware

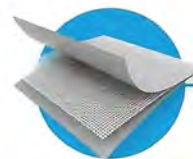

**DuraPlus™ Construction**

**Convenience**



Drain Valve



Corrosion Resistant



3-Ply PVC



No Tools Required



Packaging:  
12 ft. x 39.5 in. = Full Color Box  
14 ft. x 42 in. = Sturdy Cardboard Box with Pictures



# Steel Pro MAX™ Pools

ABOVE GROUND POOLS







Water capacity (90%): 2,708 gal. (10,250 L)

## 12 ft. x 48 in. / 3.66 m x 1.22 m

ITEM	REGION	PACK	LBS (KG)	FILTER PUMP	VOLTAGE	CARTRIDGE	LADDER	COVER	ENCLOSURE
5619K	Europe	1	141.7 (64.3)	58383 (530 gal. /2,006 L)	220-240V	58094, TYPE: II	58331	58037	✓

### Features & Technologies

FrameLink System™

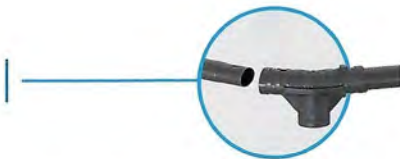

Build

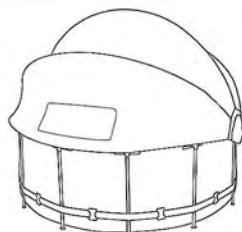

Pattern



Bottom



Hardware

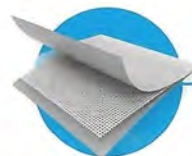

DuraPlus™ Construction

Convenience



Drain Valve



Corrosion Resistant



3-Ply PVC



No Tools Required



Packaging: Sturdy Cardboard Box with Pictures



# Steel Pro MAX™ Pools

ABOVE GROUND POOLS





Water Capacity (90%): 4,024 gal. (15,232 L)

### 14 ft. x 48 in. / 4.27 m x 1.22 m

ITEM	REGION	PACK	LBS (KG)	FILTER PUMP	VOLTAGE	CARTRIDGE	COVER	LADDER
5619C	Oceania	1	127.8 (58.0)	58386 (800 gal. /3,028 L)	220-240V	58094, TYPE: II	58248	58336
5619D	Europe	1	132.5 (60.1)	58386 (800 gal. /3,028 L)	220-240V	58094, TYPE: II	58248	58331
5619D	Asia, Africa & Latin America	1	126.0 (57.2)	58386 (800 gal. /3,028 L)	220-240V	58094, TYPE: II	58248	58336
5619C	Asia, Africa & Latin America	1	126.0 (57.2)	58387 (800 gal. /3,028 L)	110-120V	58012, TYPE: III - A/C	58248	58336

Water Capacity (90%): 5,145 gal. (19,480 L)

### 16 ft. x 48 in. / 4.88 m x 1.22 m

ITEM	REGION	PACK	LBS (KG)	FILTER PUMP	VOLTAGE	CARTRIDGE	COVER	LADDER
5619H	Oceania	1	153.6 (69.7)	58389 (1,500 gal. /5,678 L)	220-240V	58012, TYPE: III - A/C	58249	58336
5619E	Europe	1	160.5 (72.8)	58389 (1,500 gal. /5,678 L)	220-240V	58012, TYPE: III - A/C	58249	58331
5619E	Asia, Africa & Latin America	1	153.2 (69.5)	58389 (1,500 gal. /5,678 L)	220-240V	58012, TYPE: III - A/C	58249	58336
5619H	Asia, Africa & Latin America	1	153.2 (69.5)	58390 (1,500 gal. /5,678 L)	110-120V	58012, TYPE: III - A/C	58249	58336

Water Capacity (90%): 6,092 gal. (23,062 L)

### 18 ft. x 48 in. / 5.49 m x 1.22 m

ITEM	REGION	PACK	LBS (KG)	FILTER PUMP	VOLTAGE	CARTRIDGE	COVER	LADDER
5618X	Oceania	1	171.8 (77.9)	58389 (1500 gal. /5,678 L)	220-240V	58012, TYPE: III - A/C	58039	58336
5618Y	Europe	1	178.1 (80.8)	58389 (1500 gal. /5,678 L)	220-240V	58012, TYPE: III - A/C	58039	58331
5618Y	Asia, Africa & Latin America	1	171.4 (77.8)	58389 (1500 gal. /5,678 L)	220-240V	58012, TYPE: III - A/C	58039	58336
5618X	Asia, Africa & Latin America	1	171.4 (77.8)	58390 (1500 gal. /5,678 L)	110-120V	58012, TYPE: III - A/C	58039	58336

### Features & Technologies

ClickConnect System™



Build

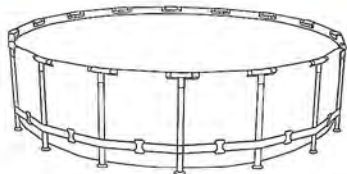

Pattern



Bottom



Hardware

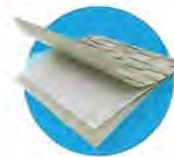

DuraPlus™ Construction

### Convenience



Drain Valve



Corrosion Resistant



3-Ply PVC



No Tools Required

Packaging: Sturdy Cardboard Box with Pictures





# Steel Pro MAX™ Pools

ABOVE GROUND POOLS



**Bestway**  
Steel Pro™  
**MAX**





Water Capacity (90%): 3,955 gal. (14,970 L)

**15 ft. x 42 in. / 4.57 m x 1.07 m**

ITEM	REGION	PACK	LBS (KG)	FILTER PUMP	VOLTAGE	CARTRIDGE	COVER	LADDER
56686	North America	1	121.7 (55.2)	58387 (800 gal. /3,028 L)	110-120V	58012, TYPE: III - A/C	58038	58335
56686	Oceania	1	121.7 (55.2)	58386 (800 gal. /3,028 L)	220-240V	58094, TYPE: II	58038	58335
56488	Europe	1	123.9 (56.2)	58386 (800 gal. /3,028 L)	220-240V	58094, TYPE: II	58038	58330
56488	Asia, Africa & Latin America	1	120.1 (54.5)	58386 (800 gal. /3,028 L)	220-240V	58094, TYPE: II	58038	58335
56686	Asia, Africa & Latin America	1	120.1 (54.5)	58387 (800 gal. /3,028 L)	110-120V	58012, TYPE: III - A/C	58038	58335

**Features & Technologies**

ClickConnect System™



Build

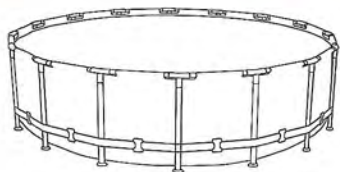

Color



Bottom



Hardware

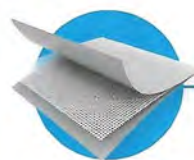

DuraPlus™ Construction

Convenience



Drain Valve



Corrosion Resistant



3-Ply PVC



No Tools Required



Packaging:  
Sturdy Cardboard Box  
with Pictures



# POWER STEEL<sup>®</sup> POOLS

## The smart choice.

The strength and security of rigid, super strong steel tube framing, plus simple, minimal-tool assembly makes a Bestway<sup>®</sup> Power Steel Pool the smart choice for families.



### TECHNOLOGY HIGHLIGHTS - PRODUCT DESIGN

#### Seal & Lock System™

Superior steel frame design



#### Frosted Finish

Prevents pool liner from sticking in a hot environment



#### ChemConnect™ Dispenser

Dispenses 1 in. / 2.54 cm chemical tablets







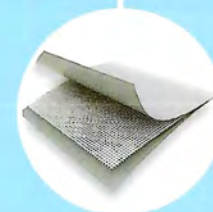







#### Tritech™

3-layer puncture resistant liner material





P R O D U C T M A T R I X - P O O L R A N G E

	2.82 m x 1.96 m x 84 cm 9'3" x 6'5" x 33"	Power Steel® Rectangular Pool	<i>Refer to International Catalog</i>
	4.04 m x 2.01 m x 1.00 m 13'3" x 6'7" x 39.5"	Power Steel® Rectangular Pool	<i>Refer to International Catalog</i>
	4.04 m x 2.01 m x 1.00 m 13'3" x 6'7" x 39.5"	Power Steel® Rectangular Pool	PG. 58
	4.12 m x 2.01 m x 1.22 m 13'6" x 6'7" x 48"	Power Steel® Rectangular Pool	<i>Refer to International Catalog</i>
	4.12 m x 2.01 m x 1.22 m 13'6" x 6'7" x 48"	Power Steel® Rectangular Pool	PG. 58
	4.88 m x 2.44 m x 1.22 m 16' x 8' x 48"	Power Steel® Rectangular Pool	<i>Refer to International Catalog</i>
	4.88 m x 2.44 m x 1.22 m 16' x 8' x 48"	Power Steel® Rectangular Pool	PG. 58
	5.49 m x 2.74 m x 1.22 m 18' x 9' x 48"	Power Steel® Rectangular Pool	<i>Refer to International Catalog</i>
	5.49 m x 2.74 m x 1.22 m 18' x 9' x 48"	Power Steel® Rectangular Pool	PG. 58
	5.49 m x 2.74 m x 1.32 m 18' x 9' x 52"	Power Steel® Rectangular Pool	PG. 60
	6.40 m x 2.74 m x 1.32 m 21' x 9' x 52"	Power Steel® Rectangular Pool	<i>Refer to International Catalog</i>
	7.32 m x 3.66 m x 1.32 m 24' x 12' x 52"	Power Steel® Rectangular Pool	<i>Refer to International Catalog</i>
	9.56 m x 4.88 m x 1.32 m 31'4" x 16' x 52"	Power Steel® Rectangular Pool	<i>Refer to International Catalog</i>



# Power Steel® Rectangular Pools

## ABOVE GROUND POOLS



### Features & Technologies



**Seal & Lock System™**  
Superior Steel Frame Design

Pattern



Bottom



Hardware



**Tritech™ Construction**

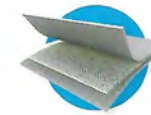

**ChemConnect™ Dispenser**

Dispenses 1 in. / 2.54 cm chemical tablets

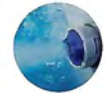

**Convenience**



Drain Valve



Corrosion Resistant



C-Connector

**Build**

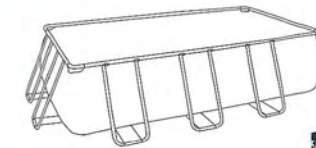

**Packaging**

Packaging: Sturdy Cardboard Box with Pictures





Water Capacity (90%): 1,711 gal. (6,478 L)

**New Design****13 ft. 3 in. x 6 ft. 7 in. x 39.5 in. / 4.04 m x 2.01 m x 1.00 m**

ITEM	REGION	PACK	LBS (KG)	FILTER PUMP	VOLTAGE	CARTRIDGE	LADDER	CHEMCONNECT™ DISPENSER
56721	Europe	1	135.2 (61.3)	58383 (530 gal. /2,006 L)	220-240V	58094, TYPE: II	58330	✓
56721	Asia, Africa & Latin America	1	133.2 (60.4)	58383 (530 gal. /2,006 L)	220-240V	58094, TYPE: II	58335	✓
56727	Asia, Africa & Latin America	1	133.2 (60.4)	58384 (530 gal. /2,006 L)	110-120V	58012, TYPE: III - A/C	58335	✓

Water Capacity (90%): 2,146 gal. (8,124 L)

**New Design****13 ft. 6 in. x 6 ft. 7 in. x 48 in. / 4.12 m x 2.01 m x 1.22 m**

ITEM	REGION	PACK	LBS (KG)	FILTER PUMP	VOLTAGE	CARTRIDGE	LADDER	CHEMCONNECT™ DISPENSER
56728	Oceania	1	157.3 (71.3)	58383 (530 gal. /2,006 L)	220-240V	58094, TYPE: II	58336	✓
56722	Europe	1	162.0 (73.5)	58383 (530 gal. /2,006 L)	220-240V	58094, TYPE: II	58331	✓
56722	Asia, Africa & Latin America	1	156.4 (70.9)	58383 (530 gal. /2,006 L)	220-240V	58094, TYPE: II	58336	✓
56728	Asia, Africa & Latin America	1	156.4 (70.9)	58384 (530 gal. /2,006 L)	110-120V	58012, TYPE: III - A/C	58336	✓

Water Capacity (90%): 3,046 gal. (11,532 L)

**New Design****16 ft. x 8 ft. x 48 in. / 4.88 m x 2.44 m x 1.22 m**

ITEM	REGION	PACK	LBS (KG)	FILTER PUMP	VOLTAGE	CARTRIDGE	COVER	LADDER	CHEMCONNECT™ DISPENSER
56995	Oceania	1	201.9 (91.6)	58386 (800 gal. /3,028 L)	220-240V	58094, TYPE: II	✓	58336	✓
56996	Europe	1	207.7 (94.2)	58386 (800 gal. /3,028 L)	220-240V	58094, TYPE: II	✓	58331	✓
56996	Asia, Africa & Latin America	1	201.0 (91.2)	58386 (800 gal. /3,028 L)	220-240V	58094, TYPE: II	✓	58336	✓
56995	Asia, Africa & Latin America	1	201.0 (91.2)	58387 (800 gal. /3,028 L)	110-120V	58012, TYPE: III - A/C	✓	58336	✓

Water Capacity (90%): 3,913 gal. (14,812 L)

**New Design****18 ft. x 9 ft. x 48 in. / 5.49 m x 2.74 m x 1.22 m**

ITEM	REGION	PACK	LBS (KG)	FILTER PUMP	VOLTAGE	CARTRIDGE	COVER	LADDER	CHEMCONNECT™ DISPENSER
56997	Oceania	1	223.4 (101.3)	58389 (1,500 gal. /5,678 L)	220-240V	58012, TYPE: III - A/C	✓	58336	✓
56998	Europe	1	233.6 (105.9)	58389 (1,500 gal. /5,678 L)	220-240V	58012, TYPE: III - A/C	✓	58331	✓
56998	Asia, Africa & Latin America	1	223.6 (101.4)	58389 (1,500 gal. /5,678 L)	220-240V	58012, TYPE: III - A/C	✓	58336	✓
56997	Asia, Africa & Latin America	1	223.6 (101.4)	58390 (1,500 gal. /5,678 L)	110-120V	58012, TYPE: III - A/C	✓	58336	✓



# Power Steel® Rectangular Pools

## ABOVE GROUND POOLS







Water Capacity (90%): 4,352 gal. (16,477 L)

**18 ft. x 9 ft. x 52 in. / 5.49 m x 2.74 m x 1.32 m**



ITEM	REGION	PACK	LBS (KG)	FILTER PUMP	VOLTAGE	CARTRIDGE	COVER	LADDER	CHEMCONNECT™ DISPENSER
5619Q	Europe	1	264.1 (119.8)	58497 (1,500 gal. / 5,678 L)	220-240V	SAND FILTER	✓	58332	✓

**Features & Technologies**

**Seal & Lock System™**

Superior Steel Frame Design



**Build**

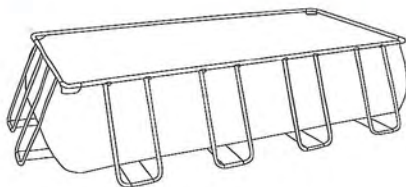

Color



Bottom



Hardware

**Tritech™ Construction**

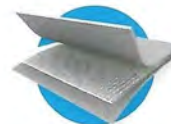

**Convenience**



Drain Valve



Corrosion Resistant



C-Connector

**ChemConnect™ Dispenser**

Dispenses 1 in. / 2.54 cm chemical tablets



Packaging: Sturdy Cardboard Box with Pictures



# POWER STEEL® SWIM VISTA SERIES™

The Power Steel® Swim Vista Series™ pools offer an incredibly unique swimming experience.

With built-in portholes, kids can wave to onlookers while gliding by, and parents can easily keep an eye on them as they swim underwater!



## TECHNOLOGY HIGHLIGHTS - PRODUCT DESIGN

### Seal & Lock System™

Superior steel frame design



### Frosted Finish

Prevents pool liner from sticking in a hot environment



### ChemConnect™ Dispenser

Dispenses 1 in. / 2.54 cm chemical tablets



### Tritech™

3-layer puncture resistant liner material

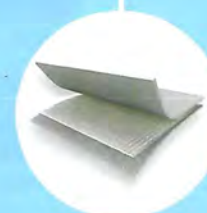



P R O D U C T M A T R I X - P O O L R A N G E

	<p>4.88 m x 1.22 m - 16' x 48"</p>	<p>Power Steel® Swim Vista Series™ II Pool</p>	<p><i>Refer to International Catalog</i></p>
	<p>5.49 m x 1.22 m - 18' x 48"</p>	<p>Power Steel® Swim Vista Series™ II Pool</p>	<p><i>Refer to International Catalog</i></p>
	<p>4.27 m x 2.50 m x 1.00 m 14' x 8'2" x 39.5"</p>	<p>Power Steel® Swim Vista Series™ II Pool</p>	<p><i>Refer to International Catalog</i></p>
	<p>4.88 m x 3.05 m x 1.07 m 16' x 10' x 42"</p>	<p>Power Steel® Swim Vista Series™ II Pool</p>	<p>PG. 64</p>
	<p>5.49 m x 2.74 m x 1.22 m 18' x 9' x 48"</p>	<p>Power Steel® Swim Vista Series™ II Pool</p>	<p><i>Refer to International Catalog</i></p>



# Power Steel® Swim Vista Series™ II Pools

## ABOVE GROUND POOLS







Water Capacity (90%): 2,893 gal. (10,949 L)

**16 ft. x 10 ft. x 42 in. / 4.88 m x 3.05 m x 1.07 m**



ITEM	REGION	PACK	LBS (KG)	FILTER PUMP	VOLTAGE	CARTRIDGE	COVER	LADDER	CHEMCONNECT™ DISPENSER
56946	Europe	1	167.5 (76.0)	58515 (800 gal. /3,028 L)	220-240V	SAND FILTER	✓	58330	✓
56946	Asia, Africa & Latin America	1	165.7 (75.2)	58515 (800 gal. /3,028 L)	220-240V	SAND FILTER	✓	58335	✓

**Features & Technologies**

**Seal & Lock System™**

Superior Steel Frame Design



**Build**

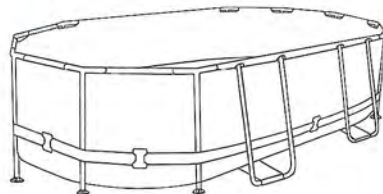

Pattern



Bottom



Hardware

**Tritech™ Construction**

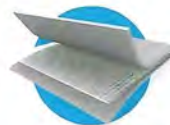

**Convenience**



Drain Valve



Corrosion Resistant



3-Ply PVC



No Tools Required

**ChemConnect™ Dispenser**

Dispensers 1 in. / 2.54 cm chemical tablets



Packaging: Sturdy Cardboard Box with Pictures



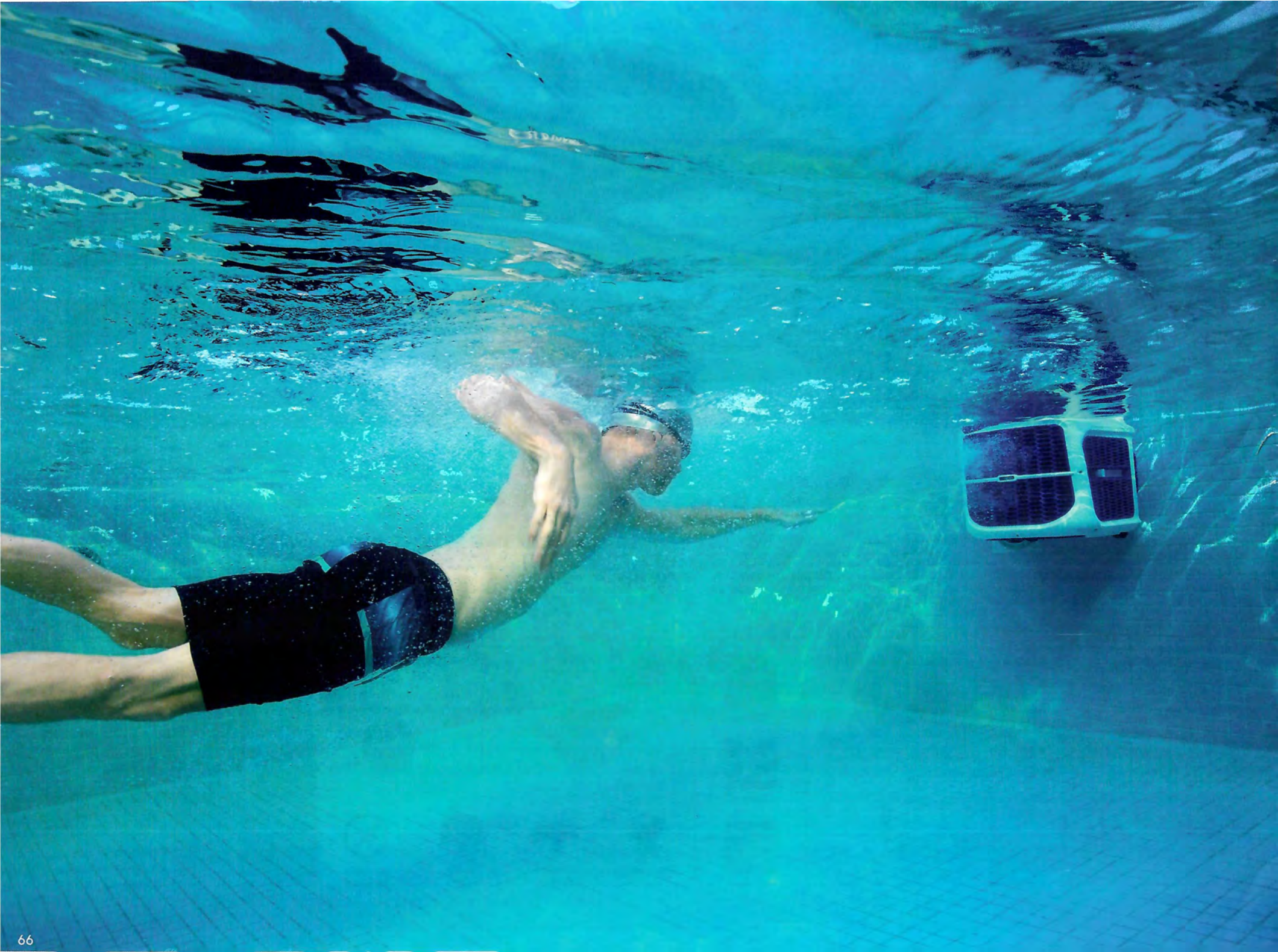



# AGP ACCESSORIES

Bestway® offers a range of pool products that can handle cleaning, maintenance, and mood. They help pool-owners enjoy their product for as long as possible.

68 Swimfinity™

70 Round Pool Dome

71 Floor Protector



# AGP ACCESSORIES



**Swimfinity™**  
58517

Take water workouts up a notch with the Swimfinity™ Swim Fitness System! Now, anyone can simulate swimming laps in any size pool. With the Swimfinity, water aerobics will never be the same!



# SWIMFINITY™

## SWIM FITNESS SYSTEM

### 58517

ITEM	REGION	RATING	SIZE	REC. POOL LENGTH & DEPTH	PACK	LBS (KG)	PACKAGING
58517	Europe	220-240V~ (PRCD)	72 cm x 48 cm x 83.50 cm / 28.35" x 18.90" x 32.87"	L: 4.57 m / 15' D: 1.00 m / 39.5"	1	118.0 (53.5)	Sturdy Cardboard Box With Pictures

- Compatible with in-ground & above ground pools greater than 1.00 m (39.5") deep, 4.57 m (15') long & 2.44 m (8') in width
- Digital LED display indicates distance, time and calories burned and provides illumination at night
- 8 variable speeds - flow speeds range from 39 m/min. (128 ft./min.) to 78 m/min. (256 ft./min.)
- Adjustable depth and water flow angle
- Remote control with elastic band
- Easy to set up; simple to operate
- PRCD plug (current surge protector)
- Output Voltage: ±12 V DC 35 A
- Input Power: 1000 W



INTENSITY LEVEL	1	2	3	4	5	6	7	8
FLOW RATE (FT./M PER MIN)	128.0 FT. 39.0 M	145.7 FT. 44.4 M	163.4 FT. 49.8 M	181.1 FT. 55.2 M	198.8 FT. 60.6 M	216.5 FT. 66.0 M	234.3 FT. 71.4 M	255.9 FT. 78.0 M





# Round Pool Dome

58612

ITEM	SIZE	CORRESPONDING POOL - FITS:	PACK	LBS (KG)
58612	6 m x 6 m x 2.95 m / 19'8" x 19'8" x 9'8"	Up to 4.88 m / 16'	1	45.0 (20.4)

- Compatible with above ground pools up to 4.88 m (16') in diameter
- UPF 50+ sun protection
- 2 entry points & 8 large, transparent windows
- Setup time: 30 min.
- Full color box





# Floor Protector

58639

ITEM	SIZE	CONTENT	COLORS	PACK	LBS (KG)
58639	50 cm x 50 cm / 20" x 20"	9 Pieces	●	30	50.3 (22.8)

- Multiple packages may be needed to cover the desired area
- Durable polyethylene
- Provides added protection for pools or spas
- Grey color allows differentiation from all the standard floor protectors and better matches with medium/high level pools
- Shrink wrapped with insert card







LAY-Z-SPA.  
SAN FRANCISCO



LAY-Z-SPA.

# PORTABLE SPAS

Nearly a decade of advanced engineering and innovations have built a global name that people know and trust. Lay-Z-Spa® offers an affordable spa experience that's convenient to use, easy to set up and offers total relaxation.

**80** Aruba Signature  
AirJet™

**84** Cancun Signature  
AirJet™

**88** Paris Luxe  
AirJet™

**92** Palm Springs  
AirJet™

**96** Mauritius  
Smart AirJet™

**102** Vancouver FortiFiber™  
Smart AirJet Plus™

**108** Toronto ThermaCore™  
Smart AirJet Plus™

**114** Cabo Smart  
HydroJet™

**118** Dominica Smart  
HydroJet™



# PRODUCT MATRIX: PORTABLE SPAS RANGE



PRODUCT NAME	ST. LUCIA	ARUBA SIGNATURE	MIAMI	CANCUN SIGNATURE	BAHAMAS SIGNATURE	FIJI SIGNATURE	BORACAY SMART
ITEM NUMBER	60037	60061	60001	60003	60005	60085	60175
MASSAGE TECH	AIRJET™	AIRJET™	AIRJET™	AIRJET™	AIRJET™	AIRJET™	AIRJET™
INFLATED SIZE	1.70 M X 66 CM (67" X 26")	1.70 M X 66 CM (67" X 26")	1.80 M X 66 CM (71" X 26")	1.80 M X 66 CM (71" X 26")	1.80 M X 66 CM (71" X 26")	1.80 M X 66 CM (71" X 26")	1.80 M X 66 CM (71" X 26")
INNER SIZE	1.24 M (49")	1.24 M (49")	1.32 M (52")	1.32 M (52")	1.32 M (52")	1.32 M (52")	1.32 M (52")
WATER CAPACITY	605 L (160 GAL.)	605 L (160 GAL.)	669 L (177 GAL.)	669 L (177 GAL.)	669 L (177 GAL.)	669 L (177 GAL.)	669 L (177 GAL.)
MATERIAL	PVC & DURAPLUS™	PVC & DURAPLUS™	PVC & DURAPLUS™	PVC & DURAPLUS™	PVC & DURAPLUS™	PVC & DURAPLUS™	PVC & DURAPLUS™
NUMBER OF AIRJETS	110	110	120	120	120	120	120
NUMBER OF WATER JETS	-	-	-	-	-	-	-
KEY FEATURES							
PAGE	Refer to International catalog	P. 80	Refer to International catalog	P. 84	Refer to International catalog	Refer to International catalog	Refer to International catalog

**FEATURES KEY:** SMART HUB™ APP | FREEZE SHIELD™ | LED LIGHTS | FOOT MASSAGE | MASSAGE REGULATION



2-4 ADULTS ROUND

3-5 ADULTS ROUND

4-6 ADULTS SQUARE























HAVANA SMART	ZURICH ENERGYSENSE™	VANCOUVER FORTIFIBER™ SMART	IBIZA	HAWAII SMART	HAWAII SMART	CABO SMART
60035	60065	60027	60015	60261	60021	60167
AIRJET™	AIRJET™	AIRJET PLUS™	AIRJET™	AIRJET™	AIRJET™	HYDROJET™
180 M X 66 CM (71" X 26")	180 M X 66 CM (71" X 26")	155 M X 60 CM (61" X 24")	180 M X 180 M X 66 CM (71" X 71" X 26")	180 M X 180 M X 66 CM (71" X 71" X 26")	180 M X 180 M X 71 CM (71" X 71" X 28")	180 M X 180 M X 71 CM (71" X 71" X 28")
1.32 M (52")	1.32 M (52")	1.45 M (57")	1.32 M X 1.32 M (52" X 52")	1.32 M X 1.32 M (52" X 52")	1.30 M X 1.30 M (51" X 51")	1.30 M X 1.30 M (51" X 51")
669 L (177 GAL.)	669 L (177 GAL.)	804 L (213 GAL.)	778 L (205 GAL.)	778 L (205 GAL.)	840 L (222 GAL.)	795 L (210 GAL.)
PVC & DURAPLUS™	PVC & DURAPLUS™ & THERMAL COVER	FORTIFIBER™	PVC & DURAPLUS™	PVC & DURAPLUS™	MAXHOLD™ & DURAPLUS™	MAXHOLD™ & DURAPLUS™
120	120	140 ON BACK & FEET	140	140	140	140
-	-	-	-	-	-	4
Refer to International catalog	Refer to International catalog	P. 102	Refer to International catalog	Refer to International catalog	Refer to International catalog	P. 114







# PRODUCT MATRIX: PORTABLE SPAS RANGE

4-6 ADULTS ROUND



PRODUCT NAME	PARIS LUXE	HOLLYWOOD LUXE	BUDAPEST ENERGYSENSE™	PALM SPRINGS	HONOLULU SMART	MILAN SMART	DOMINICA SMART
ITEM NUMBER	60013	60059	60179	60017	60019	60029	60165
MASSAGE TECH	AIRJET™	AIRJET™	AIRJET™	AIRJET™	AIRJET™	AIRJET PLUS™	HYDROJET™
INFLATED SIZE	1.96 M X 66 CM (77" X 26")	1.96 M X 66 CM (77" X 26")	1.96 M X 66 CM (77" X 26")	1.96 M X 71 CM (77" X 28")	1.96 M X 71 CM (77" X 28")	1.96 M X 71 CM (77" X 28")	1.96 M X 71 CM (77" X 28")
INNER SIZE	1.46 M (57")	1.48 M (58")	1.48 M (58")	1.46 M (57")	1.46 M (57")	1.46 M (57")	1.46 M (57")
WATER CAPACITY	806 L (213 GAL.)	908 L (240 GAL.)	908 L (240 GAL.)	916 L (242 GAL.)	916 L (242 GAL.)	916 L (242 GAL.)	810 L (214 GAL.)
MATERIAL	PVC & DURAPLUS™	PVC & DURAPLUS™	PVC & DURAPLUS™ & THERMAL COVER	MAXHOLD™ & DURAPLUS™	MAXHOLD™ & DURAPLUS™	MAXHOLD™ & DURAPLUS™	MAXHOLD™ & DURAPLUS™
NUMBER OF AIRJETS	140	140	140	140	140	140 ON BACK & FEET	140
NUMBER OF WATER JETS	-	-	-	-	-	-	4
KEY FEATURES	 	  	   		  	   	   
PAGE	P. 88	Refer to International catalog	Refer to International catalog	P. 92	Refer to International catalog	Refer to International catalog	P. 118

**FEATURES KEY:**  SMART HUB™ APP |  FREEZE SHIELD™ |  LED LIGHTS |  FOOT MASSAGE |  MASSAGE REGULATION





5-7 ADULTS ROUND				5-7 ADULTS OVAL		5-7 ADULTS SQUARE		6-8 ADULTS ROUND
<b>HELSENKI FORTIFIBER™ SMART</b>	<b>TORONTO THERMACORE™ SMART</b>	<b>ST. MORITZ SMART</b>	<b>SANTORINI SMART</b>	<b>MAURITIUS SMART</b>	<b>MALDIVES SMART</b>	<b>SAN FRANCISCO SMART</b>	<b>GRENADA SMART</b>	
60025	60163	60023	60075	60067	60033	60161	60135	
AIRJET PLUS™	AIRJET PLUS™	AIRJET™	HYDROJET PRO™	AIRJET™	HYDROJET PRO™	HYDROJET PRO™	AIRJET™	
1.80 M X 66 CM (71" X 26")	1.90 M X 70 CM (75" X 27.5")	2.16 M X 71 CM (85" X 28")	2.16 M X 80 CM (85" X 31.5")	2.70 M X 1.80 M X 71 CM (8'11" X 7'1" X 28")	2.01 M X 2.01 M X 80 CM (79" X 79" X 31.5")	2.30 M X 2.30 M X 71 CM (90.5" X 90.5" X 28")	2.36 M X 71 CM (93" X 28")	
1.70 M (67")	1.70 M (67")	1.66 M (65")	1.66 M (65")	2.20 M X 1.30 M (7'3" X 5'1")	1.51 M X 1.51 M (59" X 59")	1.80 M X 1.80 M (71" X 71")	1.86 M (73")	
1,123 L (297 GAL.)	1,300 L (345 GAL.)	1,190 L (314 GAL.)	1,190 L (314 GAL.)	1,370 L (362 GAL.)	1,050 L (277 GAL.)	1,180 L (312 GAL.)	1,350 L (357 GAL.)	
FORTIFIBER™	RIGID FOAM PANELS	MAXHOLD™ & DURAPLUS™	MAXHOLD™ & DURAPLUS™	MAXHOLD™ & DURAPLUS™	MAXHOLD™ & DURAPLUS™	MAXHOLD™ & DURAPLUS™	MAXHOLD™ & DURAPLUS™	
180 ON BACK & FEET	180 ON BACK & FEET	180	180 ON BACK & FEET	180	180 ON BACK & FEET	180 ON BACK & FEET	190	
-	-	-	10	-	8	10	-	
Refer to International catalog	P. 108	Refer to International catalog	Refer to International catalog	P. 96	Refer to International catalog	Refer to International catalog	Refer to International catalog	



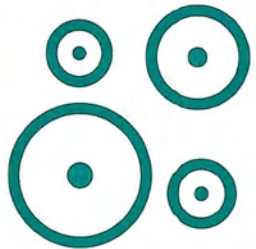

# AIRJET™ SYSTEM

**FLOAT AWAY ON A CLOUD OF BUBBLES  
WITH AN AIRJET MASSAGE.**

Soothe your body and relax your mind with the touch of a button. Simply press the massage button on the control panel, and the AirJet system will surround you with calming bubbles.



## MULTI-FUNCTION PUMP

The included spa pump is convenient and accessible, complete with a digital interface and cup holders. This pump inflates the spa, starts the heating and massage systems, and can activate the filtration system. The best part is that the design now allows users to adjust their needs without standing up or exiting the spa.



**EASY TO REACH  
CONTROL PANEL**



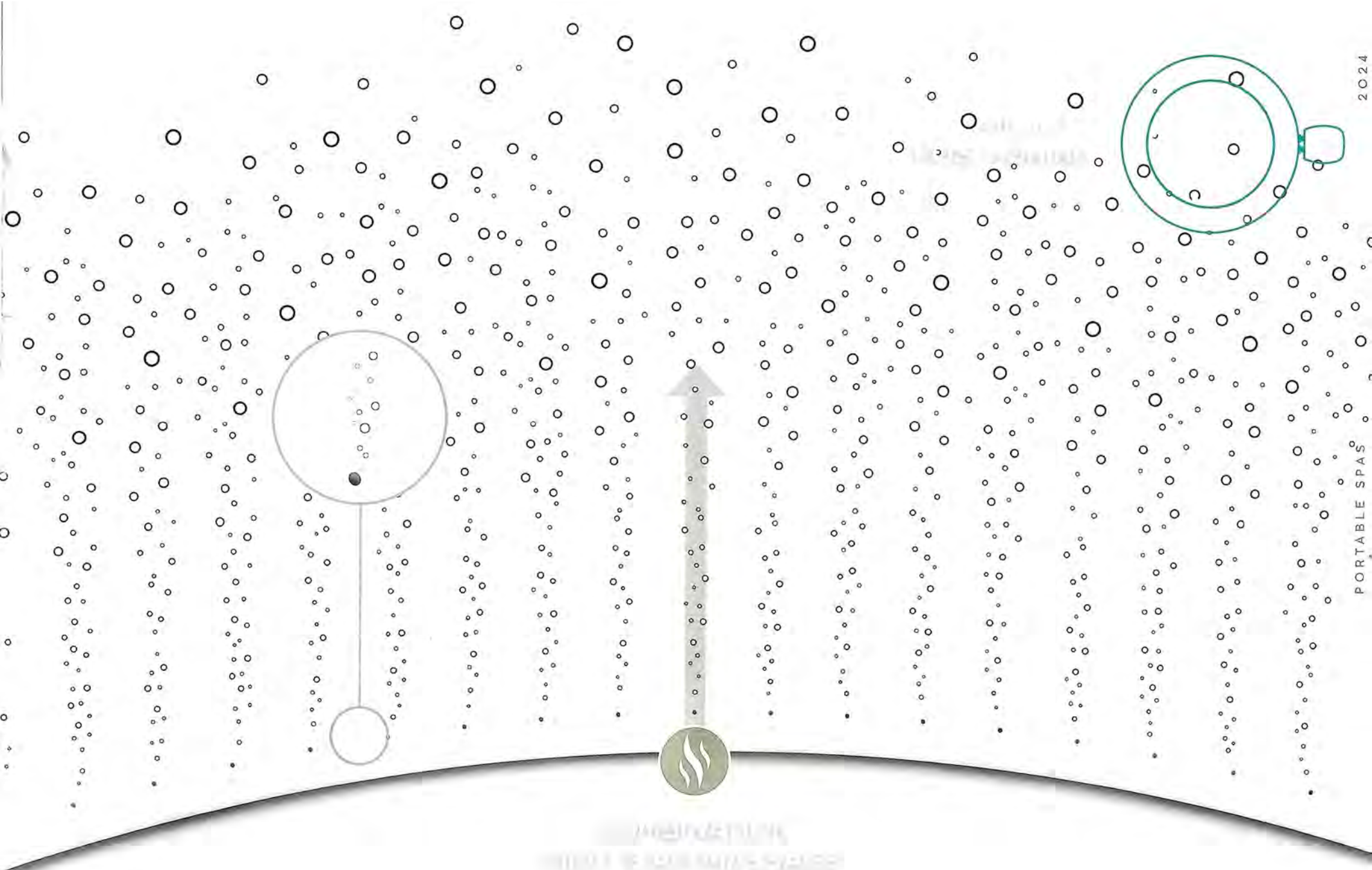



# PORTABLE SPAS



## Aruba Signature AirJet™

60061

FREEZE  
SHIELD™  
TECHNOLOGY



CAPACITY  
2-3  
PEOPLE







## Main features:

- Soothing AirJet™ bubble massage system (110 jets)
- Ultra-strong DuraPlus™ walls are stress tested to offer durability
- Freeze Shield™ automatic heating prevents water from freezing & damaging the spa
- Program the spa heater up to 40 days in advance for future use
- ChemConnect™ dispenser provides a stable level of chlorine throughout the spa
- Power-saving, timer-controlled heating system
- Digital control panel & spa pump with integrated filtration system includes cup holders and is accessible from inside the spa
- Reinforced cover with safety lock clips

*Contents: 1 spa, 1 pool cover, 1 spa pump, filter cartridge (VI), 1 ChemConnect™ dispenser, repair patch, AirJet™ system*



Filter Cartridge



ChemConnect™



DuraPlus™ Exterior Cover

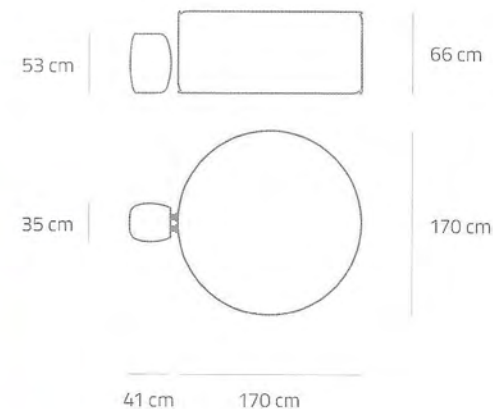





## SPA FEATURES



WARM AIR



MAX TEMP  
40°C (104°F)



GROUND FAULT  
DETECTION SYSTEM  
\* MOST SPAS HAVE GROUND FAULT  
DETECTION SYSTEM (GDS).



NO TOOLS  
REQUIRED



POWER  
SAVING TIMER

## PACKAGING

Packaging: Full Color Box



## DURAPLUS™ WALL & TOP RING

The outer surface of this spa is constructed with premium DuraPlus™ material, providing superior durability, stretch resistance and structural stability.

## SPECIFICATIONS

ITEM NUMBER	60061
WATER CAPACITY	605 L (160 GAL.)
INFLATED SIZE	1.70 M X 66 CM (67" X 26")
INNER SIZE	1.24 M (49")
FILLED WEIGHT	630 KG (1,389 LBS)
RATING	220-240V- 50HZ, 2050W AT 20°C (68°F)
ACTUAL WATER FLOW	1,325 L/H (350 GAL./H)
HEATING SYSTEM	APPROX. 1.5 - 2.0°C/H (3-4°F/H)
CERTIFICATION	CE/GS
PACK/ GROSS WEIGHT	1 EA., 32.41 KG (71.45 LBS)





## AIRJET™ MASSAGE SYSTEM

Soothe your body and relax your mind with the touch of a button! The Airjets work by releasing warm air into the water, surrounding you with a calming bubble massage.



## FREEZE SHIELD™ TECHNOLOGY

These spas have built-in sensors so water temperature never falls below your comfort level. Freeze Shield automatically increases water circulation when temperatures are low to prevent inner parts from becoming damaged.

## DIGITAL CONTROL PANEL

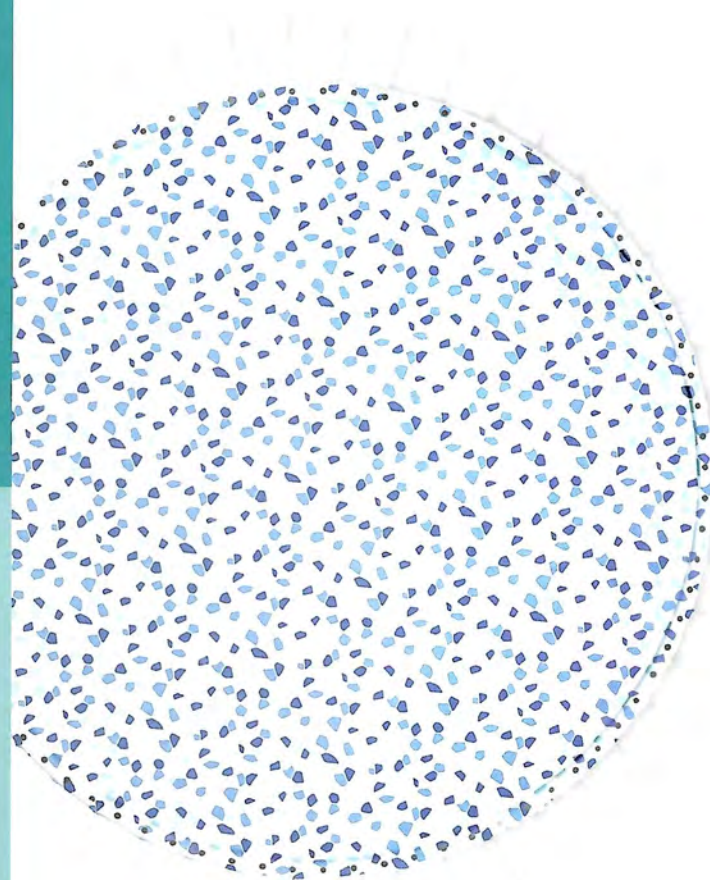
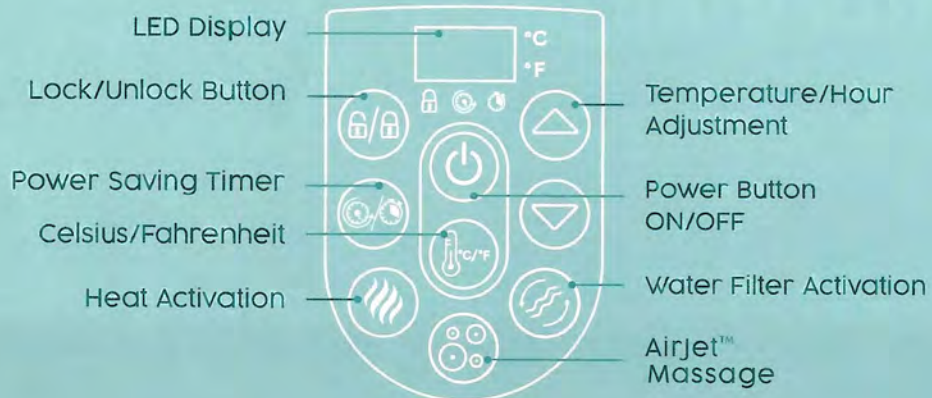



# PORTABLE SPAS



## Cancun Signature AirJet™

60003

FREEZE  
SHIELD™  
TECHNOLOGY



CAPACITY  
2-4  
PEOPLE







## Main features:

- Soothing AirJet™ bubble massage system (120 jets)
- Ultra-strong DuraPlus™ walls are stress tested to offer durability
- Freeze Shield™ automatic heating prevents water from freezing & damaging the spa
- Program the spa heater up to 40 days in advance for future use
- ChemConnect™ dispenser provides a stable level of chlorine throughout the spa
- Power-saving, timer-controlled heating system
- Digital control panel & spa pump with integrated filtration system includes cup holders and is accessible from inside the spa
- Reinforced cover with safety lock clips

*Contents: 1 spa, 1 pool cover, 1 spa pump, filter cartridge (VI), 1 ChemConnect™ dispenser, repair patch, AirJet™ system*



Filter Cartridge



ChemConnect™



DuraPlus™ Exterior Cover

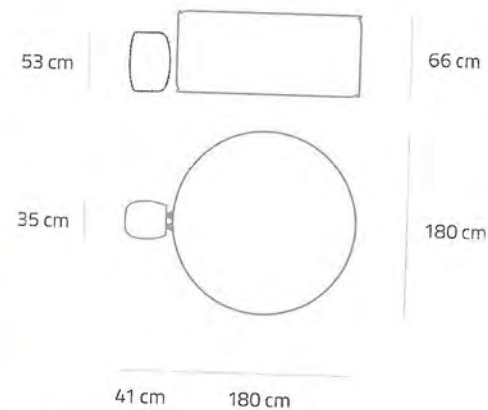





## SPA FEATURES



WARM AIR



40 °C

MAX TEMP  
40°C (104°F)



GROUND FAULT  
DETECTION SYSTEM

\* MOST SPAS HAVE GROUND FAULT  
DETECTION SYSTEM (GDS).

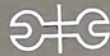

NO TOOLS  
REQUIRED



POWER  
SAVING TIMER

## PACKAGING

Packaging: Full Color Box



## DURAPLUS™ WALL & TOP RING

The outer surface of this spa is constructed with premium DuraPlus™ material, providing superior durability, stretch resistance and structural stability.

## SPECIFICATIONS

ITEM NUMBER	60003
WATER CAPACITY	669 L (177 GAL.)
INFLATED SIZE	1.80 M X 66 CM (71" X 26")
INNER SIZE	1.32 M (52")
FILLED WEIGHT	696 KG (1,534 LBS)
RATING	220-240V- 50HZ, 2050W AT 20°C (68°F)
ACTUAL WATER FLOW	1,325 L/H (350 GAL./H)
HEATING SYSTEM	APPROX. 1.5 - 2.0°C/H (3-4°F/H)
CERTIFICATION	CE/GS
PACK/ GROSS WEIGHT	1 EA., 33.93 KG (74.80 LBS)





## AIRJET™ MASSAGE SYSTEM

Soothe your body and relax your mind with the touch of a button! The Airjets work by releasing warm air into the water, surrounding you with a calming bubble massage.



## FREEZE SHIELD™ TECHNOLOGY

These spas have built-in sensors so water temperature never falls below your comfort level. Freeze Shield automatically increases water circulation when temperatures are low to prevent inner parts from becoming damaged.

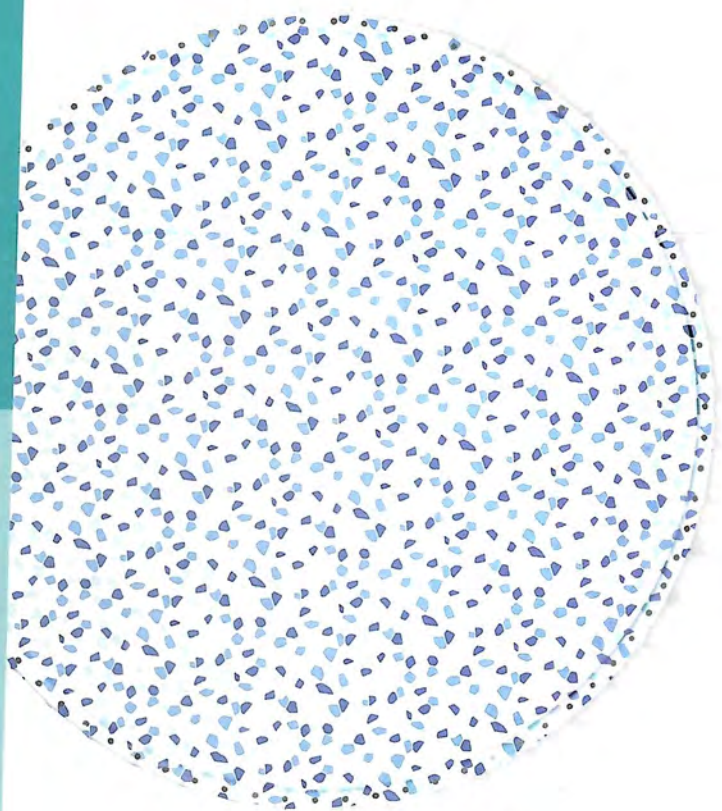

## DIGITAL CONTROL PANEL

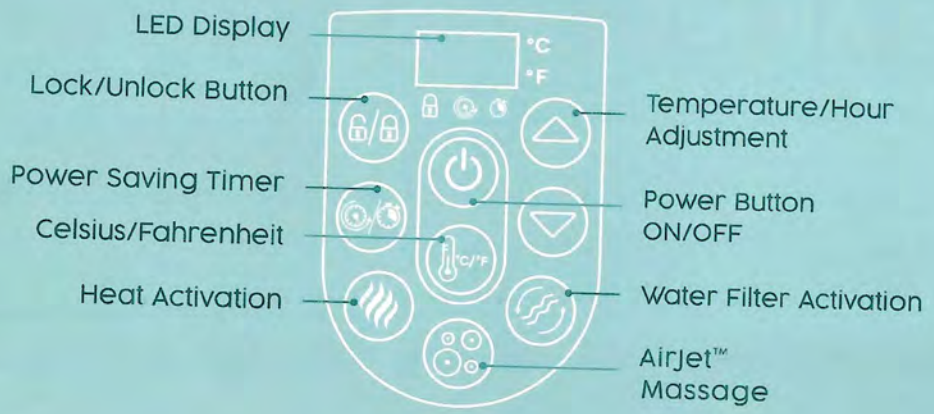



# PORTABLE SPAS



## Paris Luxe AirJet™

60013

FREEZE  
SHIELD™  
TECHNOLOGY



WIRELESS  
LED REMOTE  
CONTROL



CAPACITY  
4-6  
PEOPLE







## Main features:

- Soothing AirJet™ bubble massage system (140 jets)
- Freeze Shield™ automatic heating prevents water from freezing & damaging the spa
- Program the spa heater up to 40 days in advance for future use
- ChemConnect™ dispenser provides a stable level of chlorine throughout the spa
- Remote-controlled multicolored LED lights
- Power-saving, timer-controlled heating system
- Digital control panel & spa pump with integrated filtration system includes cup holders and is accessible from inside the spa
- Reinforced cover with safety lock clips

*Contents: 1 spa, 1 pool cover, 1 spa pump, 1 ChemConnect™ dispenser, filter cartridge (M), 1 LED light strip, repair patch, AirJet™ system*



Filter Cartridge      ChemConnect™      7-Color LED Light Strip



41 cm      196 cm







## SPA FEATURES



WARM AIR



MAX TEMP  
40°C (104°F)



GROUND FAULT  
DETECTION SYSTEM  
\* MOST SPAS HAVE GROUND FAULT  
DETECTION SYSTEM (GDS).

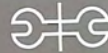

NO TOOLS  
REQUIRED



POWER  
SAVING TIMER



LED  
LIGHT

## PACKAGING

Packaging: Full Color Box



## DURAPLUS™ COVER

Exterior cover is DuraPlus™, providing superior durability, stretch resistance and structural stability.

## SPECIFICATIONS

ITEM NUMBER	60013
WATER CAPACITY	806 L (213 GAL.)
INFLATED SIZE	1.96 M X 66 CM (77" X 26")
INNER SIZE	1.46 M (57")
FILLED WEIGHT	840 KG (1,851 LBS)
RATING	220-240V- 50HZ, 2050W AT 20°C (68°F)
ACTUAL WATER FLOW	1,325 L/H (350 GAL./H)
HEATING SYSTEM	APPROX. 1.5 - 2.0°C/H (3-4°F/H)
CERTIFICATION	CE/GS
PACK/ GROSS WEIGHT	1 EA., 40.07 KG (88.34 LBS)





## AIRJET™ MASSAGE SYSTEM

Soothe your body and relax your mind with the touch of a button! The Airjets work by releasing warm air into the water, surrounding you with a calming bubble massage.



## FREEZE SHIELD™ TECHNOLOGY

These spas have built-in sensors so water temperature never falls below your comfort level. Freeze Shield automatically increases water circulation when temperatures are low to prevent inner parts from becoming damaged.

## DIGITAL CONTROL PANEL

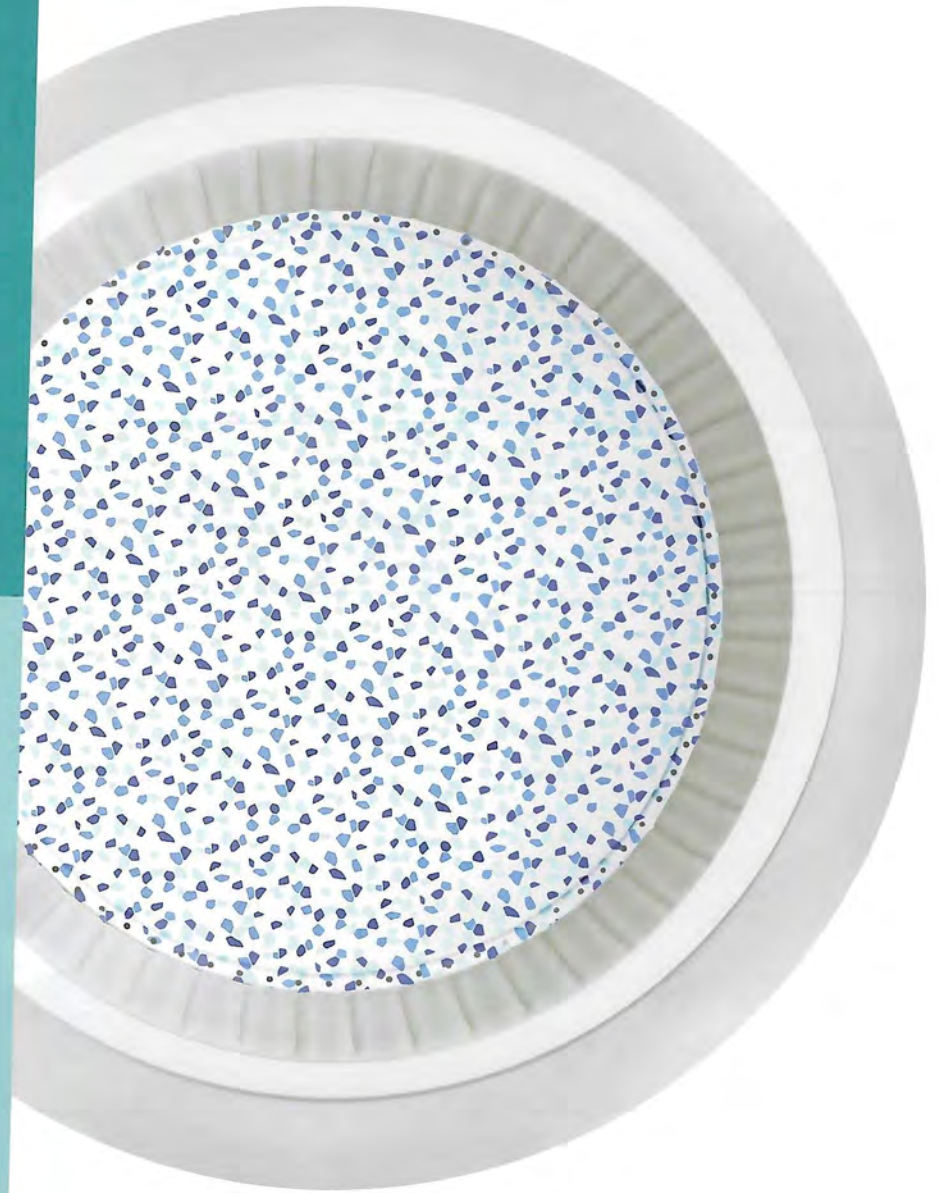
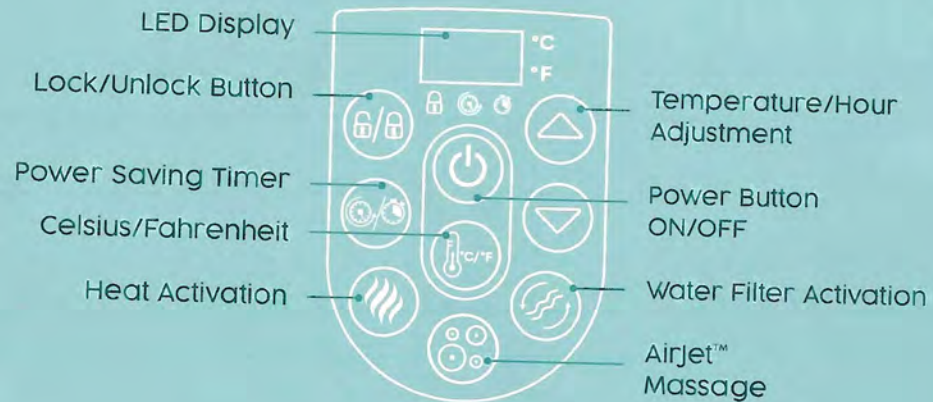



# PORTABLE SPAS



## Palm Springs AirJet™

60017

NEW  
GENERATION!

FREEZE  
SHIELD™  
TECHNOLOGY



CAPACITY  
4-6  
PEOPLE







## Main features:

- Soothing AirJet™ bubble massage system (140 jets)
- Ultra-strong DuraPlus™ walls are stress tested to offer durability
- MaxHold™ fabric internal beams provide superior air pressure retention, stability and lightweight portability
- Freeze Shield™ automatic heating prevents water from freezing & damaging the spa
- Program the spa heater up to 40 days in advance for future use
- ChemConnect™ dispenser provides a stable level of chlorine throughout the spa
- Power-saving, timer-controlled heating system
- Digital control panel & spa pump with integrated filtration system includes cup holders and is accessible from inside the spa
- Reinforced cover with safety lock clips

*Contents: 1 spa, 1 pool cover, 1 spa pump, 1 ChemConnect™ dispenser, 1 filter cartridge (VI), repair patch, AirJet™ system*



Filter Cartridge



ChemConnect™



DuraPlus™ Exterior Cover

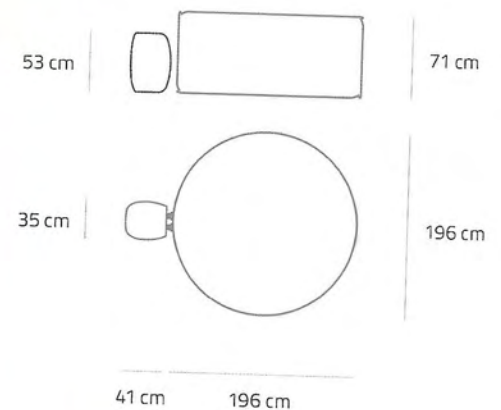





## SPA FEATURES



WARM AIR



40 °C

MAX TEMP  
40 °C (104 °F)



GROUND FAULT  
DETECTION SYSTEM

\* MOST SPAS HAVE GROUND FAULT  
DETECTION SYSTEM (GDS).



NO TOOLS  
REQUIRED



POWER  
SAVING TIMER

## PACKAGING

Packaging: Full Color Box



## DURAPLUS™ WALL & TOP RING

The outer surface of this spa is constructed with premium DuraPlus™ material, providing superior durability, stretch resistance and structural stability.



## MAXHOLD™ BEAMS

MaxHold™ internal beams maintain their shape over time, enabling the spa to hold its intended pressure and sturdiness. Made from a durable fabric material rather than PVC, they set the standard for internal stretch-resistance in the spa market.

## SPECIFICATIONS

ITEM NUMBER	60017
WATER CAPACITY	916 L (242 GAL.)
INFLATED SIZE	1.96 M X 71 CM (77" X 28")
INNER SIZE	1.46 M (57")
FILLED WEIGHT	947 KG (2,088 LBS)
RATING	220-240V- 50HZ, 2050W AT 20 °C (68 °F)
ACTUAL WATER FLOW	1,325 L/H (350 GAL./H)
HEATING SYSTEM	APPROX. 1.5 - 2.0 °C/H (3-4 °F/H)
CERTIFICATION	CE/GS
PACK/ GROSS WEIGHT	1 EA., 38.50 KG (84.88 LBS)





## AIRJET™ MASSAGE SYSTEM

Soothe your body and relax your mind with the touch of a button! The AirJets work by releasing warm air into the water, surrounding you with a calming bubble massage.



## FREEZE SHIELD™ TECHNOLOGY

These spas have built-in sensors so water temperature never falls below your comfort level. Freeze Shield automatically increases water circulation when temperatures are low to prevent inner parts from becoming damaged.

## DIGITAL CONTROL PANEL

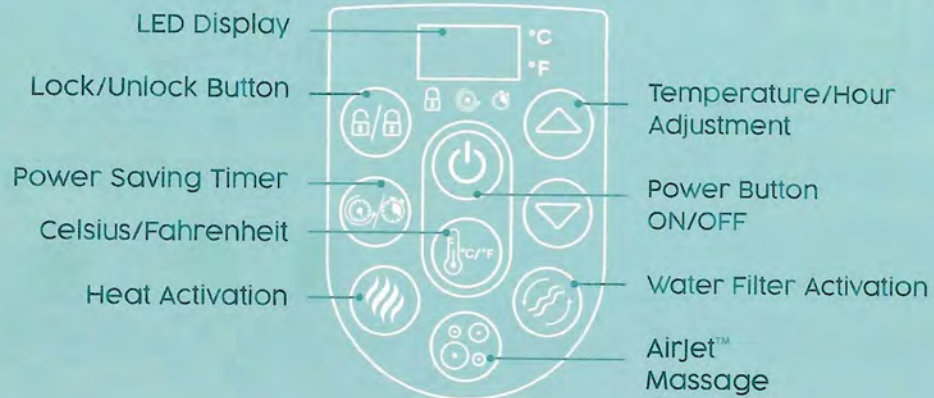



# PORTABLE SPAS



## Mauritius Smart AirJet™

60067

NEW  
GENERATION!

FREEZE  
SHIELD™  
TECHNOLOGY



CAPACITY  
5-7  
PEOPLE



BESTWAY  
SMART HUB™  
APP







LAY-Z-SPA.  
MAURITIUS

**NEW WOODEN  
EMBOSSING**

Main features:

- Soothing AirJet™ bubble massage system (180 jets)
- Massage regulator provides 2 intensity level options
- Ultra-strong DuraPlus™ walls are stress tested to offer durability
- MaxHold™ fabric internal beams provide superior air pressure retention, stability and lightweight portability
- Freeze Shield™ automatic heating prevents water from freezing & damaging the spa
- Program the spa heater up to 40 days in advance for future use
- Built-in Wi-Fi module, spa can be controlled through a phone app
- ChemConnect™ dispenser provides a stable level of chlorine throughout the spa
- Power-saving, timer-controlled heating system
- Digital control panel & spa pump with integrated filtration system includes two cup holders and is accessible from inside the spa
- Reinforced cover with safety lock clips

*Contents: 1 spa, 1 pool cover, 1 spa pump, 1 ChemConnect™ dispenser, filter cartridge (VI), repair patch, AirJet™ system*



Filter Cartridge



ChemConnect™



DuraPlus™ Exterior Cover

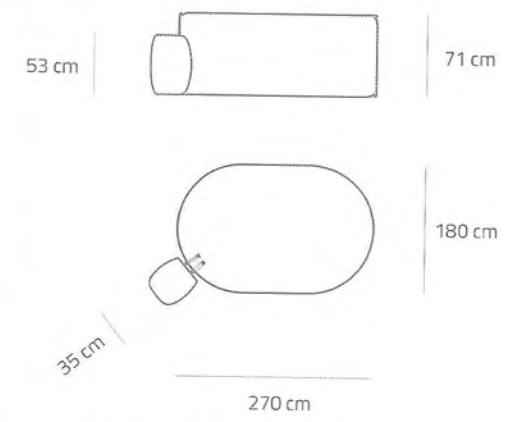



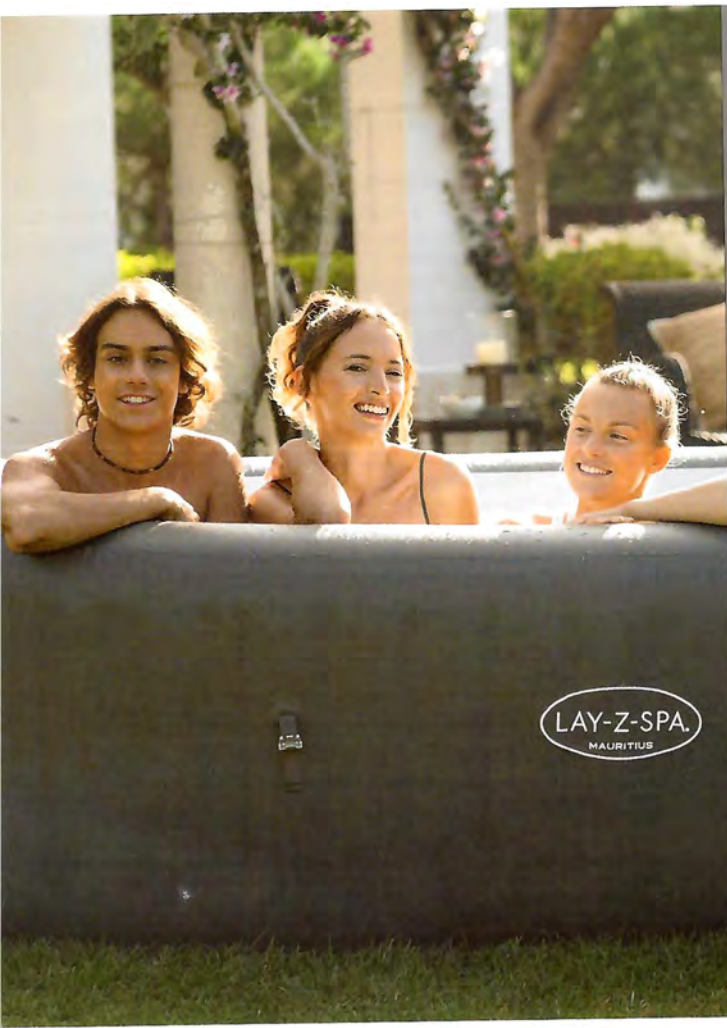

## PACKAGING

Packaging: Full Color Box



## SPA FEATURES



WARM AIR



MAX TEMP  
40°C (104°F)



GROUND FAULT  
DETECTION SYSTEM

\* MOST SPAS HAVE GROUND FAULT  
DETECTION SYSTEM (GDS).



NO TOOLS  
REQUIRED



POWER  
SAVING TIMER



MASSAGE  
REGULATION  
2 Intensity Levels



## DURAPLUS™ WALL & TOP RING

The outer surface of this spa is constructed with premium DuraPlus™ material, providing superior durability, stretch resistance and structural stability.



## MAXHOLD™ BEAMS

MaxHold™ internal beams maintain their shape over time, enabling the spa to hold its intended pressure and sturdiness. Made from a durable fabric material rather than PVC, they set the standard for internal stretch-resistance in the spa market.

## SPECIFICATIONS

ITEM NUMBER	60067
WATER CAPACITY	1,370 L (362 GAL.)
INFLATED SIZE	2.70 M X 1.80 M X 71 CM (8'11" X 71" X 28")
INNER SIZE	2.20 M X 1.30 M (7'3" X 51")
FILLED WEIGHT	1,408 KG (3,103 LBS)
RATING	220-240V- 50HZ, 2050W AT 20°C (68°F)
ACTUAL WATER FLOW	1,325 L/H (350 GAL./H)
HEATING SYSTEM	APPROX. 1.0 - 1.5°C/H (2-3°F/H)
CERTIFICATION	CE/GS
PACK/ GROSS WEIGHT	1 EA., 46.30 KG (102.07 LBS)





## AIRJET™ MASSAGE SYSTEM

Soothe your body and relax your mind with the touch of a button! The AirJets work by releasing warm air into the water, surrounding you with a calming bubble massage.



## FREEZE SHIELD™ TECHNOLOGY

These spas have built-in sensors so water temperature never falls below your comfort level. Freeze Shield automatically increases water circulation when temperatures are low to prevent inner parts from becoming damaged.



## BESTWAY SMART HUB™ APP

This innovation makes the Lay-Z-Spa compatible with smart devices. The Spa Control section of the app lets users set their spa to the perfect temperature. They can also activate the Power-Saving Timer, the water filter, and the AirJet massage system with the touch of a button!

## DIGITAL CONTROL PANEL

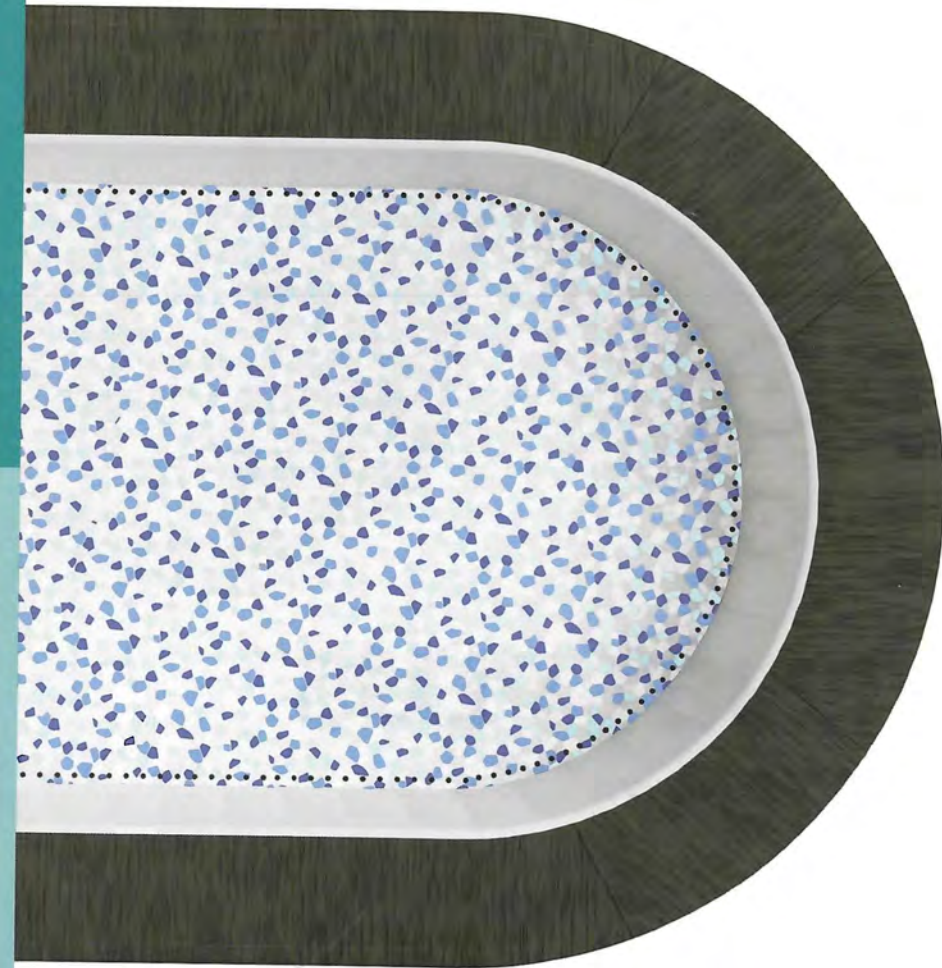



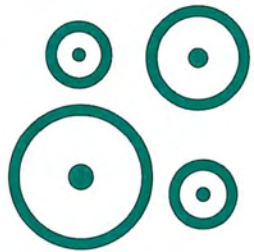

# AIRJET PLUS™ SYSTEM

**MASSAGING BUBBLES ARE  
THE PERFECT WAY TO UNWIND.**

The AirJet Plus system releases bubbles from both the bottom and the sidewalls of the spa to target both the legs and back.



## MULTI-FUNCTION PUMP

The included spa pump is convenient and accessible, complete with a digital interface and cup holders. This pump inflates the spa, starts the heating and massage systems, and can activate the filtration system. The best part is that the design now allows users to adjust their needs without standing up or exiting the spa.



**EASY TO REACH  
CONTROL PANEL**





COMBINATION  
HEAT & AIR MASSAGE

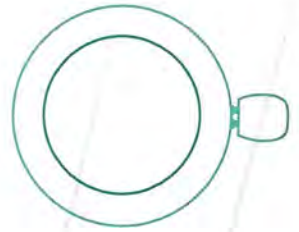

## FOOT MASSAGE

The AirJet Plus™ system features additional jets, specifically placed to provide a relaxing foot massage. By placing another circle of massage bubbles in the center of the spa, we are able to target the legs as well as the back of the user.



# PORTABLE SPAS



## Vancouver FortiFiber™ Smart AirJet Plus™

60027

FREEZE  
SHIELD™  
TECHNOLOGY



CAPACITY  
3-5  
PEOPLE



BESTWAY  
SMART HUB™  
APP







## Main features:

- Soothing AirJet Plus™ targeted bubble massage system (140 jets)
- Massage regulator provides 2 intensity level options
- Walls are made of FortiFiber™ material, providing a strong and durable hard-sided spa
- Freeze Shield™ automatic heating prevents water from freezing damaging the spa
- Program the spa heater up to 40 days in advance for future use
- Built-in Wi-Fi module, spa can be controlled through a phone app
- ChemConnect™ dispenser provides a stable level of chlorine throughout the spa
- Power-saving, timer-controlled heating system
- Digital control panel & spa pump with integrated filtration system includes cup holders and is accessible from inside the spa
- Reinforced cover with safety lock clips

*Contents: 1 spa, 1 pool cover, 1 spa pump, 1 ChemConnect™ dispenser, 1 high pressure hand pump, filter cartridge (VI), repair patch, AirJet Plus™ system*



Filter Cartridge



ChemConnect™



DuraPlus™ Exterior Cover

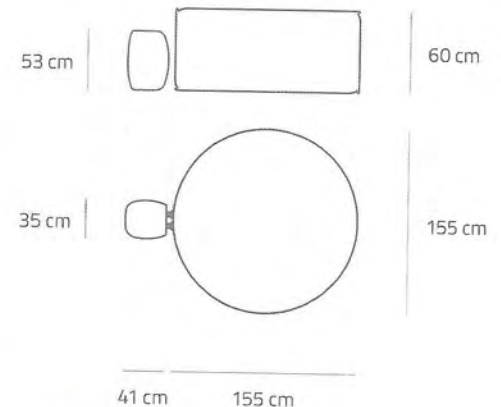





## SPA FEATURES



WARM AIR



40 °C

MAX TEMP  
40°C (104°F)



GROUND FAULT  
DETECTION SYSTEM

\* MOST SPAS HAVE GROUND FAULT  
DETECTION SYSTEM (GDS).



NO TOOLS  
REQUIRED



POWER  
SAVING TIMER



MASSAGE  
REGULATION  
2 Intensity Levels

## PACKAGING

Packaging: Full Color Box

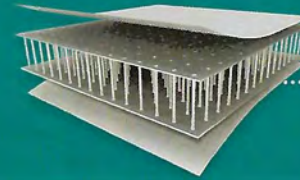

## FORTIFIBER™ MATERIAL STRENGTH & DURABILITY

The inflated walls are made from drop stitch material, providing unparalleled strength and durability. Thousands of fine threads securely connect the sidewalls, which seal in air to keep the spa inflated. This material can support considerable weight while still being light and portable when deflated.

## SPECIFICATIONS

ITEM NUMBER	60027
WATER CAPACITY	804 L (213 GAL.)
INFLATED SIZE	1.55 M X 60 CM (61" X 24")
INNER SIZE	1.45 M (57")
FILLED WEIGHT	831 KG (1,833 LBS)
RATING	220-240V- 50HZ, 2050W AT 20°C (68°F)
ACTUAL WATER FLOW	1,325 L/H (350 GAL./H)
HEATING SYSTEM	APPROX. 1.5 - 2.0°C/H (3-4°F/H)
CERTIFICATION	CE/GS
PACK/ GROSS WEIGHT	1 EA., 33.72 KG (74.34 LBS)





## AIRJET PLUS™ SYSTEM

Enjoy a deeper massage with AirJet Plus! Air bubbles are released from both the bottom and the sidewalls of the spa to target both the legs and back.



## FREEZE SHIELD™ TECHNOLOGY

These spas have built-in sensors so water temperature never falls below your comfort level. Freeze Shield automatically increases water circulation when temperatures are low to prevent inner parts from becoming damaged.



## BESTWAY SMART HUB™ APP

This innovation makes the Lay-Z-Spa compatible with smart devices. The Spa Control section of the app lets users set their spa to the perfect temperature. They can also activate the Power-Saving Timer, the water filter, and the AirJet massage system with the touch of a button!

## DIGITAL CONTROL PANEL

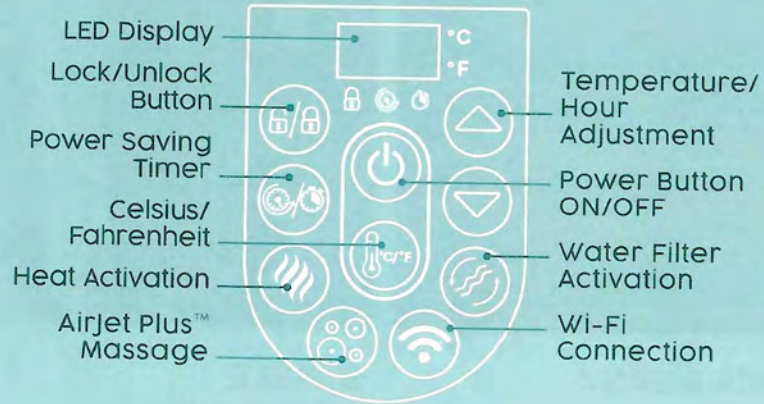





# THERMACORE™ CONSTRUCTION

NEW AND UNIQUE CONSTRUCTION MADE  
WITH RIGID FOAM MATERIAL PANELS  
ENCASED IN DURAPLUS™ MATERIAL



QUICK & EASY  
ASSEMBLY



STABLE  
STRUCTURE









# Toronto ThermaCore™ Smart AirJet Plus™

60163

NEW  
GENERATION!

FREEZE  
SHIELD™  
TECHNOLOGY



CAPACITY  
5-7  
PEOPLE



PADDED  
PILLOWS



BESTWAY  
SMART HUB™  
APP







LAY-Z-SPA.  
TORONTO

## Main features:

- Soothing AirJet Plus™ targeted bubble massage system (180 jets)
- Massage regulator provides 2 intensity level options
- ThermaCore™ construction provides a sturdier, more durable option that is as much as 60% more energy-efficient than a traditional inflatable spa
- Ultra-strong DuraPlus™ wall cover is stress tested to offer durability
- Freeze Shield™ automatic heating prevents water from freezing & damaging the spa
- Program the spa heater up to 40 days in advance for future use
- Built-in Wi-Fi module, spa can be controlled through a phone app
- ChemConnect™ dispenser provides a stable level of chlorine throughout the spa
- Power-saving, timer-controlled heating system
- Digital control panel & spa pump with integrated filtration system includes cup holders and is accessible from inside the spa
- Reinforced cover with safety lock clips
- Padded pillows provide an ultra-comfortable experience

*Contents: 1 spa, 1 pool cover, 1 spa pump, 5 pillows, 1 ChemConnect™ dispenser, filter cartridge (VI), repair patch, AirJet Plus™ system*



Filter Cartridge



ChemConnect™



DuraPlus™ Exterior Cover



Pillow

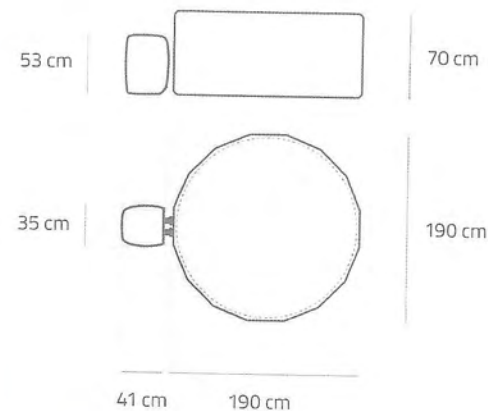





## SPA FEATURES



WARM AIR



MAX TEMP  
40°C (104°F)



GROUND FAULT  
DETECTION SYSTEM  
\* MOST SPAS HAVE GROUND FAULT  
DETECTION SYSTEM (GDS).



NO TOOLS  
REQUIRED



POWER  
SAVING TIMER



1x 2x  
MASSAGE  
REGULATION  
2 Intensity Levels

## PACKAGING

Packaging: Sturdy  
Cardboard Box  
with Pictures



## THERMACORE™ CONSTRUCTION AND DURAPLUS™ COVER

The foam wall provides a stable structure and a longer lifespan. It is covered with DuraPlus™ material to offer superior durability, stretch resistance and structural stability.



## INSULATED WALLS

Foam walls speed up heating time and prevents heat loss, making the Toronto as much as 60% more energy efficient than similar spas.

## SPECIFICATIONS

ITEM NUMBER	60163
WATER CAPACITY	1,300 L (345 GAL.)
CONSTRUCTED SIZE	1.90 M X 70 CM (75" X 27.5")
INNER SIZE	1.70 M (67")
FILLED WEIGHT	1,340 KG (2,954 LBS)
RATING	220-240V- 50HZ, 2050W AT 20°C (68°F)
ACTUAL WATER FLOW	1,325 L/H (350 GAL./H)
HEATING SYSTEM	APPROX. 1.1-1.6°C/H (2.2-3.2°F/H)
CERTIFICATION	CE/GS
PACK/ GROSS WEIGHT	1 EA., 53.11 KG (117.09 LBS)





## AIRJET PLUS™ SYSTEM

Enjoy a deeper massage with AirJet Plus! Air bubbles are released from both the bottom and the sidewalls of the spa to target both the legs and back.



## FREEZE SHIELD™ TECHNOLOGY

These spas have built-in sensors so water temperature never falls below your comfort level. Freeze Shield automatically increases water circulation when temperatures are low to prevent inner parts from becoming damaged.



## BESTWAY SMART HUB™ APP

This innovation makes the Lay-Z-Spa compatible with smart devices. The Spa Control section of the app lets users set their spa to the perfect temperature. They can also activate the Power-Saving Timer, the water filter, and the AirJet massage system with the touch of a button!

## DIGITAL CONTROL PANEL

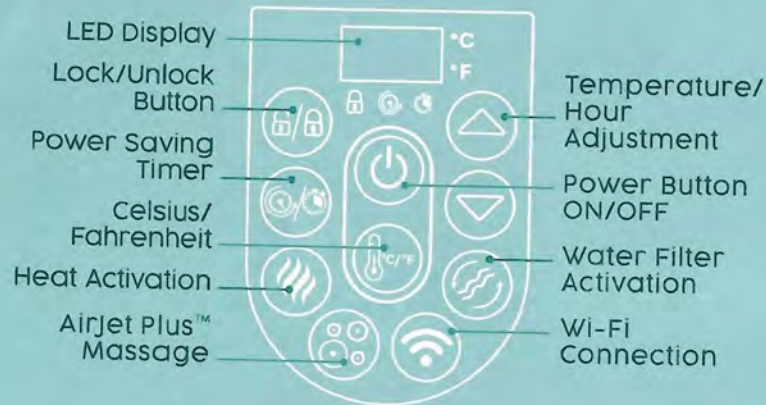



# PORTABLE SPAS



## Cabo Smart Hydrojet™

60167

NEW  
GENERATION!

FREEZE  
SHIELD™  
TECHNOLOGY



CAPACITY  
4-6  
PEOPLE



PADDED  
PILLOWS



BESTWAY  
SMART HUB™  
APP







## Main features:

- Hydrodynamic water jetstream and air bubble massage system (4 jetstream nozzles and 140 jets)
- Massage regulator provides 2 intensity level options
- Ultra-strong DuraPlus™ walls are stress tested to offer durability
- MaxHold™ fabric internal beams provide superior air pressure retention, stability and lightweight portability
- Freeze Shield™ automatic heating prevents water from freezing & damaging the spa
- Program the spa heater up to 40 days in advance for future use
- Built-in Wi-Fi module, spa can be controlled through a phone app
- ChemConnect™ dispenser provides a stable level of chlorine throughout the spa
- Power-saving, timer-controlled heating system
- Digital control panel & spa pump with integrated filtration system includes cup holders and is accessible from inside the spa
- Reinforced cover with safety lock clips
- Padded pillows provide an ultra-comfortable experience

*Contents: 1 spa, 1 pool cover, 1 spa pump, 1 ChemConnect™ dispenser, 4 pillows, filter cartridge (VI), repair patch, HydroJet™ system*

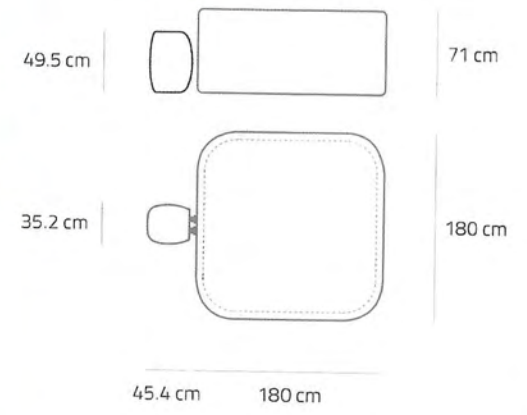





## SPA FEATURES



WARM AIR



40 °C

MAX TEMP  
40°C (104°F)



GROUND FAULT  
DETECTION SYSTEM

\* MOST SPAS HAVE GROUND FAULT  
DETECTION SYSTEM (GDS).



NO TOOLS  
REQUIRED



POWER  
SAVING TIMER



MASSAGE  
REGULATION  
2 Intensity Levels

## PACKAGING

Packaging: Full Color Box



## DURAPLUS™ WALL & TOP RING

The outer surface of this spa is constructed with premium DuraPlus™ material, providing superior durability, stretch resistance and structural stability.



## MAXHOLD™ BEAMS

MaxHold™ internal beams maintain their shape over time, enabling the spa to hold its intended pressure and sturdiness. Made from a durable fabric material rather than PVC, they set the standard for internal stretch-resistance in the spa market.

## SPECIFICATIONS

ITEM NUMBER	60167
WATER CAPACITY	795 L (210 GAL.)
INFLATED SIZE	1.80 M X 1.80 M X 71 CM (71" X 71" X 28")
INNER SIZE	1.30 M X 1.30 M (51" X 51")
FILLED WEIGHT	835 KG (1,841 LBS)
RATING	220-240V- 50HZ, 2150W AT 20°C (68°F)
ACTUAL WATER FLOW	3,975 L/H (1,050 GAL./H)
HEATING SYSTEM	APPROX. 1.5 - 2.0°C/H (3-4°F/H)
CERTIFICATION	CE
PACK/ GROSS WEIGHT	1 EA., 49.35 KG (108.80 LBS)





## HYDROJET™ MASSAGE SYSTEM

HydroJet™ is the best of both worlds! Adjustable nozzles that release water bubbles combined with AirJets along the bottom provide the ultimate hydrotherapy massage.



## FREEZE SHIELD™ TECHNOLOGY

These spas have built-in sensors so water temperature never falls below your comfort level. Freeze Shield automatically increases water circulation when temperatures are low to prevent inner parts from becoming damaged.



## BESTWAY SMART HUB™ APP

This innovation makes the Lay-Z-Spa compatible with smart devices. The Spa Control section of the app lets users set their spa to the perfect temperature. They can also activate the Power-Saving Timer, the water filter, and the Hydrojet massage system with the touch of a button!

## DIGITAL CONTROL PANEL

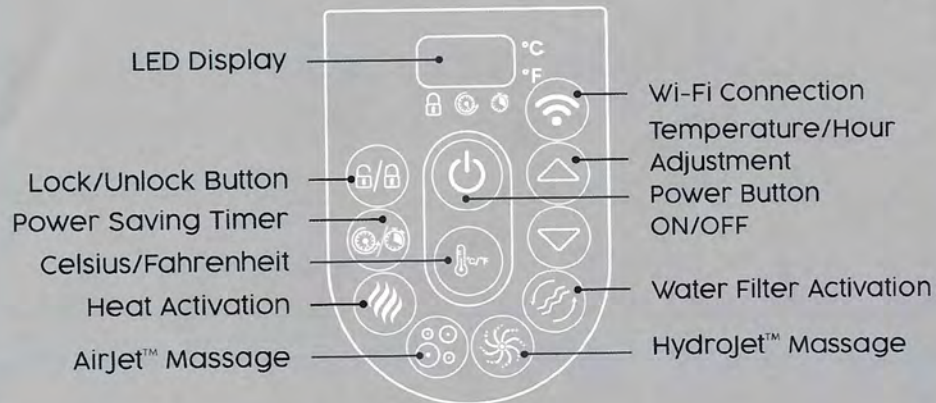





## SPA FEATURES



WARM AIR



MAX TEMP  
40°C (104°F)



GROUND FAULT  
DETECTION SYSTEM  
\* MOST SPAS HAVE GROUND FAULT  
DETECTION SYSTEM (GDS).



NO TOOLS  
REQUIRED



POWER  
SAVING TIMER



MASSAGE  
REGULATION  
2 Intensity Levels

## PACKAGING

Packaging: Full Color Box



## DURAPLUS™ WALL & TOP RING

The outer surface of this spa is constructed with premium DuraPlus™ material, providing superior durability, stretch resistance and structural stability.



## MAXHOLD™ BEAMS

MaxHold™ internal beams maintain their shape over time, enabling the spa to hold its intended pressure and sturdiness. Made from a durable fabric material rather than PVC, they set the standard for internal stretch-resistance in the spa market.

## SPECIFICATIONS

ITEM NUMBER	60165
WATER CAPACITY	810 L (214 GAL.)
INFLATED SIZE	1.96 M X 71 CM (77" X 28")
INNER SIZE	1.46 M (57")
FILLED WEIGHT	850 KG (1,874 LBS)
RATING	220-240V- 50HZ, 2150W AT 20°C (68°F)
ACTUAL WATER FLOW	3,975 L/H (1,050 GAL./H)
HEATING SYSTEM	APPROX. 1.5 - 2.0°C/H (3-4°F/H)
CERTIFICATION	CE
PACK/ GROSS WEIGHT	1 EA., 49.01 KG (108.05 LBS)





## HYDROJET™ MASSAGE SYSTEM

Hydrojet™ is the best of both worlds! Adjustable nozzles that release water bubbles combined with Airjets along the bottom provide the ultimate hydrotherapy massage.



## FREEZE SHIELD™ TECHNOLOGY

These spas have built-in sensors so water temperature never falls below your comfort level. Freeze Shield automatically increases water circulation when temperatures are low to prevent inner parts from becoming damaged.



## BESTWAY SMART HUB™ APP

This innovation makes the Lay-Z-Spa compatible with smart devices. The Spa Control section of the app lets users set their spa to the perfect temperature. They can also activate the Power-Saving Timer, the water filter, and the Hydrojet massage system with the touch of a button!

## DIGITAL CONTROL PANEL

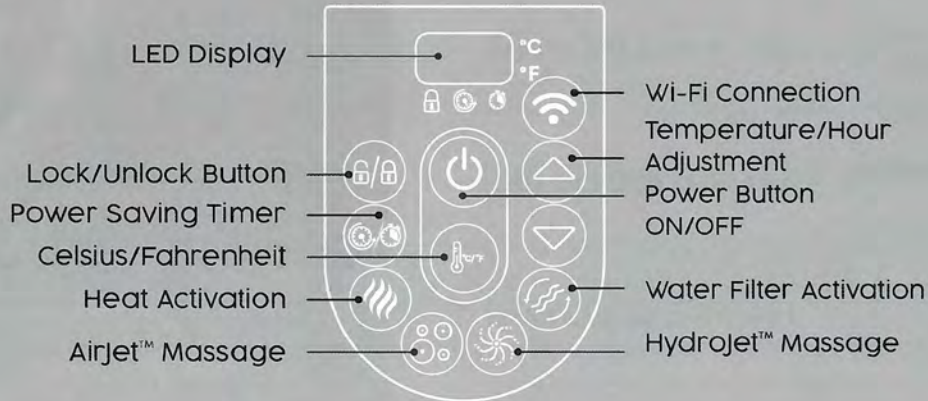



# EnergySense™ Thermal Spa Cover Round

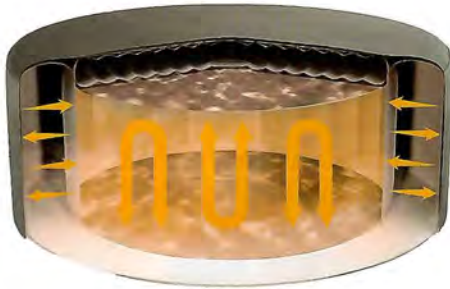

- Increases energy efficiency of the spa
- DuraPlus™ waterproof surface material increases cover durability
- Zipper door for built-in pump or external pump connection
- Full color box

ITEM	SIZE	COMPATIBILITY	COMPATIBILITY	WEIGHT
60330	1.70 m x 66 cm / 67" x 26"	Compatible with round spas with diameters of 1.70 m (67") and heights of 66 cm (26")	60037, 60061	1 EA., 6.69 KG (14.75 LBS)
60317	1.80 m x 66 cm / 71" x 26"	Compatible with round spas with diameters of 1.80 m (71") and heights of 66 cm (26")	60001, 60003, 60005, 60025, 60035, 60085, 60175	1 EA., 7.38 KG (16.27 LBS)
60318	1.96 m x 71 cm / 77" x 28"	Compatible with round spas with diameters of 1.96 m (77") and heights of 71 cm (28")	60017, 60019, 60029, 60059, 60165	1 EA., 7.72 KG (17.02 LBS)
60326	2.16 m x 80 cm / 85" x 31.5"	Compatible with round spas with diameters of 2.16 m (85") and heights between 71 cm (28") and 80 cm (31.5")	60023, 60075	1 EA., 10.42 KG (22.97 LBS)
60331	2.36 m x 71 cm / 93" x 28"	Compatible with round spas with diameters of 2.36 m (93") and heights of 71 cm (28")	60135	1 EA., 11.60 KG (25.57 LBS)





# EnergySense™ Thermal Spa Cover Square

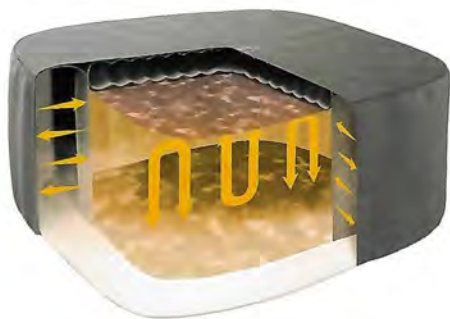

- Increases energy efficiency of the spa
- DuraPlus™ waterproof surface material increases cover durability
- Zipper door for built-in pump or external pump connection
- Full color box

ITEM	SIZE	COMPATIBILITY	COMPATIBILITY	WEIGHT
60319	1.80 m x 1.80 m x 71 cm / 71" x 71" x 28"	Compatible with square spas with lengths of 1.80 m (71") and heights of 71 cm (28")	60015, 60021, 60167, 60261	1 EA., 7.54 KG (16.62 LBS)
60332	2.01 m x 2.01 m x 80 cm / 79" x 79" x 31.5"	Compatible with square spas with lengths of 2.01 m (79") and heights of 80 cm (31.5")	60033	1 EA., 11.13 KG (24.54 LBS)
60333	2.30 m x 2.30 m x 71 cm / 90.5" x 90.5" x 28"	Compatible with square spas with lengths of 2.30 m (90.5") and heights of 71 cm (28")	60161	1 EA., 12.60 KG (27.78 LBS)



2024

PORTABLE SPAS

## PACKAGING





# TECHNICAL FEATURES & ACCESSORY COMPATIBILITY



LAY-Z-SPA® ACCESSORIES		60327 LAY-Z-SPA® RECHARGEABLE UNDERWATER VACUUM	60323 LAY-Z-SPA® UNDERWATER VACUUM	60321 LAY-Z-SPA® SEAT	60322 LAY-Z-SPA® SOOTHING LED WATERFALL	60304 LAY-Z-SPA® CANOPY
AIRJET™	60037- ST. LUCIA	.	.	.	.	NO
	60061-ARUBA SIGNATURE	.	.	.	.	NO
	60001-MIAMI	.	.	.	.	.
	60005-BAHAMAS SIGNATURE	.	.	.	.	.
	60003-CANCUN SIGNATURE	.	.	.	.	.
	60085-FIJI SIGNATURE	.	.	.	.	.
	60035-HAVANA SMART	.	.	.	.	.
	60175-BORACAY SMART	.	.	.	.	.
	60261-HAWAII SMART	.	.	.	.	.
	60015-IBIZA	.	.	.	.	.
	60059 -HOLLYWOOD LUXE	.	.	.	.	.
	60013-PARIS LUXE	.	.	.	.	.
	60065-ZURICH ENERGYSENSE™	.	.	.	.	.
	60179-BUDAPEST ENERGYSENSE™	.	.	.	.	.
	60017- PALM SPRING	.	.	.	.	.
	60019-HONOLULU SMART	.	.	.	.	.
	60021-HAWAII SMART	.	.	.	.	.
	60023-ST. MORITZ SMART	.	.	.	.	.
	60067-MAURITIUS SMART	.	.	.	.	.
	60135-GRENADA SMART	.	.	.	.	.
AIRJET PLUS™	60029-MILAN SMART	.	.	.	.	.
	60163-TORONTO THERMACORE™ SMART	.	.	.	.	.
	60025-HELSINKI FORTIFIBER™ SMART	.	.	.	.	.
	60027-VANCOUVER FORTIFIBER™ SMART	.	.	.	.	NO
HYDROJET™	60165-DOMINICA SMART	.	NO	.	NO	.
	60167-CABO SMART	.	NO	.	NO	.
HYDROJET PRO™	60075-SANTORINI SMART	.	NO	.	NO	.
	60033-MALDIVES SMART	.	NO	.	NO	.
	60161-SAN FRANCISCO SMART	.	NO	.	NO	.









HYDRO-FORCE

GF<sup>TM</sup>

HYDRO-FORCE

GF<sup>TM</sup>

HAWAII 10



# HYDRO-FORCE™ BOARDS

The engineering team at Bestway® has crafted and fine-tuned each stand-up paddleboard year after year to offer consumers the most premium option at an affordable price.

**130** Sea Breeze Set

**132** White Cap Convertible Set

**134** Breeze Panorama™ Set

**136** Huaka'i Set



# PRODUCT MATRIX: HYDRO-FORCE™ SUP RANGE

ALL-AROUND

New

**AQUA JOURNEY set**  
65349

**SEA BREEZE set**  
65340

**WHITE CAP set**  
65342

**WHITE CAP convertible set**  
65341

**OCEANA convertible set**  
65350

**HUAKA'I set**  
65346

**AQUA DRIFTER™ set**  
65391

**BREEZE PANORAMA™ set**  
65377

12 ft. (3.66 m)  
11 ft. (3.35 m)  
10 ft. (3.05 m)  
9 ft. (2.74 m)  
8 ft. (2.44 m)  
7 ft. (2.13 m)  
6 ft. (1.83 m)  
5 ft. (1.52 m)  
4 ft. (1.22 m)  
3 ft. (91 cm)  
2 ft. (61 cm)  
1 ft. (30 cm)



LENGTH	9 ft. (2.74 m)	10 ft. (3.05 m)	10 ft. (3.05 m)	10 ft. (3.05 m)	10 ft. (3.05 m)	10 ft. (3.05 m)	11 ft. (3.35 m)	10 ft. (3.05 m)	
WIDTH	30 in. (76 cm)	33 in. (84 cm)	33 in. (84 cm)	33 in. (84 cm)	33 in. (84 cm)	33 in. (84 cm)	33 in. (84 cm)	33 in. (84 cm)	
THICKNESS	4.75 in. (12 cm)	4.75 in. (12 cm)	4.75 in. (12 cm)	4.75 in. (12 cm)	4.75 in. (12 cm)	6 in. (15 cm)	6 in. (15 cm)	4.75 in. (12 cm)	
WEIGHT CAPACITY	220 lbs (100 kg)	265 lbs (120 kg)	265 lbs (120 kg)	265 lbs (120 kg)	265 lbs (120 kg)	287 lbs (130 kg)	309 lbs (140 kg)	243 lbs (110 kg)	
INTERNAL VOLUME	55 gal. (208 L)	67 gal. (256 L)	67 gal. (256 L)	67 gal. (256 L)	67 gal. (256 L)	84 gal. (320 L)	91 gal. (343 L)	61 gal. (232 L)	
PRESSURE	15 psi (1.03 bar)	15 psi (1.03 bar)	15 psi (1.03 bar)	15 psi (1.03 bar)	15 psi (1.03 bar)	15 psi (1.03 bar)	15 psi (1.03 bar)	15 psi (1.03 bar)	
SEATED OPTION									
OARS	•	•	•	•	•	•	•	•	
FINS	☾	☾	☾	☾	☾	☾	☾☾	☾	
OVERALL PERFORMANCE	<p>MANEUVERABILITY</p> <p>STABILITY</p> <p>TRACKING</p> <p>SPEED</p>	<p>MANEUVERABILITY</p> <p>STABILITY</p> <p>TRACKING</p> <p>SPEED</p>	<p>MANEUVERABILITY</p> <p>STABILITY</p> <p>TRACKING</p> <p>SPEED</p>	<p>MANEUVERABILITY</p> <p>STABILITY</p> <p>TRACKING</p> <p>SPEED</p>	<p>MANEUVERABILITY</p> <p>STABILITY</p> <p>TRACKING</p> <p>SPEED</p>	<p>MANEUVERABILITY</p> <p>STABILITY</p> <p>TRACKING</p> <p>SPEED</p>	<p>MANEUVERABILITY</p> <p>STABILITY</p> <p>TRACKING</p> <p>SPEED</p>	<p>MANEUVERABILITY</p> <p>STABILITY</p> <p>TRACKING</p> <p>SPEED</p>	<p>MANEUVERABILITY</p> <p>STABILITY</p> <p>TRACKING</p> <p>SPEED</p>
PAGE	Refer to International Catalog	PG. 130	Refer to International Catalog	PG. 132	Refer to International Catalog	PG. 136	Refer to International Catalog	PG. 134	







# BOARDS



## Sea Breeze Set

~~~~~ 65340 ~~~~~





**Inflated Size** 10' x 33" x 4.75"  
(3.05 m x 84 cm x 12 cm)

**Category** All-Around

**Features** FortiFiber™

**Contents** Paddleboard, paddle, hand pump, backpack, coiled leash, fin, repair kit



**Weight Capacity** 265 lbs (120 kg)

**Passengers** 1

**Case Pack** 1 pcs

**Lb. (kg)** 27.1 lbs (12.3 kg)

**Packaging** Full color box





# BOARDS



## White Cap Convertible Set

65341





**Inflated Size** 10' x 33" x 4.75"  
(3.05 m x 84 cm x 12 cm)

**Category** All-Around

**Features** FortiFiber™

**Contents** Paddleboard, paddle, hand pump, backpack, coiled leash, seat, footrest, fin, repair kit



**Weight Capacity** 265 lbs (120 kg)

**Passengers** 1

**Case Pack** 1 pcs

**Lb. (kg)** 30.6 lbs (13.9 kg)

**Packaging** Full color box





# BOARDS



## Breeze Panorama™ Set

65377





**Inflated Size** 10' x 33" x 4.75"  
(3.05 m x 84 cm x 12 cm)

**Category** All-Around

**Features** FortiFiber™

**Contents** Paddleboard, paddle, hand pump, backpack, coiled leash, fin, repair kit



**Weight Capacity** 243 lbs (110 kg)

**Passengers** 1

**Case Pack** 1 pcs

**Lb. (kg)** 28.0 lbs (12.7 kg)

**Packaging** Full color box





# BOARDS



## Huaka'i Set

65346





**Inflated Size** 10' x 33" x 6"  
(3.05 m x 84 cm x 15 cm)

**Category** All-Around

**Features** FortiFiber™

**Contents** Paddleboard, paddle, hand pump, backpack, coiled leash, fin, repair kit



**Weight capacity** 287 lbs (130 kg)

**Passengers** 1

**Case Pack** 1 pcs

**Lb. (kg)** 31.5 lbs (14.3 kg)

**Packaging** Full color box





# WFS<sup>TM</sup> HYDRO-FORCE<sup>TM</sup>





# HYDRO-FORCE™ KAYAKS

The wide range of kayaks offered by Bestway® means every water explorer can find exactly what they're looking for. From different sizes to materials, these kayaks are perfect for beginners and advanced adventurers.

**142** Kayak  
Surge Elite™ X1

**144** Kayak  
Surge Elite™ X2

**146** Kayak  
Waypoint Elite™ x2



# PRODUCT MATRIX: HYDRO-FORCE™ KAYAKS RANGE

COVE CHAMPION™ X1  
65115

COVE CHAMPION™ X2  
65131

RAPID™ X2  
65077

RAPID™ X3  
65132

RAPID ELITE™ X2  
65142

12 ft. (3.66 m)  
11 ft. (3.35 m)  
10 ft. (3.05 m)  
9 ft. (2.74 m)  
8 ft. (2.44 m)  
7 ft. (2.13 m)  
6 ft. (1.83 m)  
5 ft. (1.52 m)  
4 ft. (1.22 m)  
3 ft. (91 cm)  
2 ft. (61 cm)  
1 ft. (30 cm)

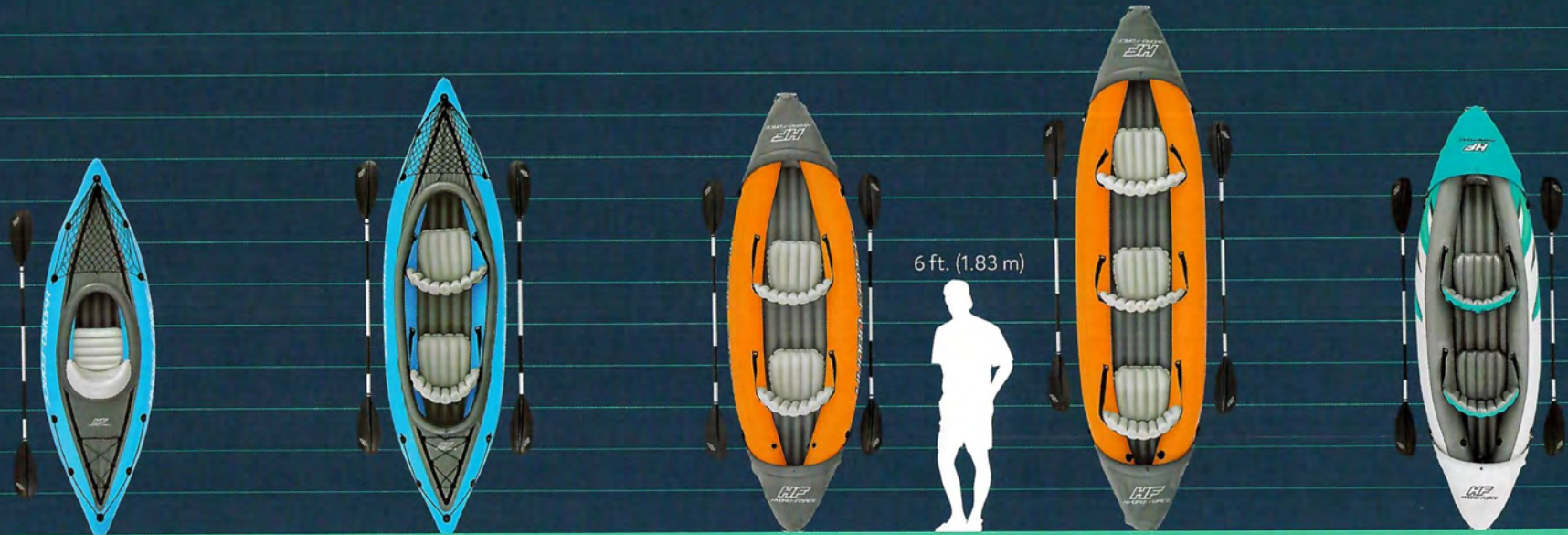

|                   |                                |                                |                                |                                |                                |
|-------------------|--------------------------------|--------------------------------|--------------------------------|--------------------------------|--------------------------------|
| INFLATED LENGTH   | 9 ft. (2.75 m)                 | 10 ft. 10 in. (3.31 m)         | 10 ft. 6 in. (3.21 m)          | 12 ft. 6 in. (3.81 m)          | 10 ft. 3 in. (3.12 m)          |
| INFLATED WIDTH    | 32 in. (81 cm)                 | 35 in. (88 cm)                 | 39 in. (1.00 m)                | 39 in. (1.00 m)                | 39 in. (98 cm)                 |
| WEIGHT CAPACITY   | 220 lbs (100 kg)               | 397 lbs (180 kg)               | 397 lbs (180 kg)               | 551 lbs (250 kg)               | 397 lbs (180 kg)               |
| INTERNAL PRESSURE | 0.5 psi (0.034 bar)            | 0.5 psi (0.034 bar)            | 0.6 psi (0.041 bar)            | 1 psi (0.069 bar)              | 1 psi (0.069 bar)              |
| PADDLES           | 1                              | 2                              | 2                              | 2                              | 2                              |
| PASSENGERS        | 1                              | 2                              | 2                              | 3                              | 2                              |
| PAGES             | Refer to International Catalog | Refer to International Catalog | Refer to International Catalog | Refer to International Catalog | Refer to International Catalog |



VENTURA ELITE™ X1  
65118

VENTURA ELITE™ X2  
65052

SURGE ELITE™ X1  
65143

SURGE ELITE™ X2  
65144

New

WAYPOINT ELITE™ X2  
65167

KORACLE™ X1  
65097



9 ft. 2 in. (2.80 m)

10 ft. 10 in. (3.30 m)

10 ft. 3 in. (3.12 m)

12 ft. 8 in. (3.86 m)

12 ft. 6 in. (3.82 m)

9 ft. 4 in. (2.85 m)

34 in. (86 cm)

34 in. (86 cm)

38 in. (96 cm)

38 in. (96 cm)

40 in. (1.01 m)

36 in. (92 cm)

286 lbs (130 kg)

440 lbs (200 kg)

220 lbs (100 kg)

397 lbs (180 kg)

397 lbs (180 kg)

331 lbs (150 kg)

1 psi (0.069 bar)

1 psi (0.069 bar)

2 psi (0.138 bar)

2 psi (0.138 bar)

2 psi (0.138 bar) / 5 psi (0.345 bar)

0.5 psi (0.034 bar)

1

2

1

2

2

1

1

2

1

2

2

1

Refer to International Catalog

Refer to International Catalog

PG. 142

PG. 144

PG. 146

Refer to International Catalog



# KAYAK



Surge Elite™ X1

65143





## Compliance / Certification

- User capacity: 1 adult
- Weight capacity: 100 kg (220 lbs)

## Structure Specs

- Inflated size: 3.12 m x 96 cm x 35 cm / 10'3" x 38" x 14"
- Deflated size: 3.16 m x 99 cm / 10'4" x 39"
- 3 air chamber construction
- Walls made with 1000D Tritech™ - a 3-ply ultra-reinforced material
- Ultra-Fresh® antimicrobial treatment (containing zinc pyrithione technology) is manufactured into the PVC film to protect the surface from odor-causing bacteria, mold and mildew growth
- Firm and rigid inflated floor

## Features & Design

- 1 adjustable seat with storage compartment
- Form-fitted construction prevents water from entering the cockpit
- 2 removable fins in different sizes for directional support in various water conditions
- Safety grab ropes
- 2 carry handles
- Air Hammer™ inflation pump (#62086)
- 230 cm (91") aluminum paddle (#62174)
- 1 floor-mounted footrest
- Carry bag for easy transportation and storage

## Valves

- Quick inflation/deflation screw valves

## Packaging

- Full color box
- 1 Ea., 14.0 kg (30.9 lbs)

## Contents

- 1 kayak, 1 paddle, 1 hand pump, 2 fins, 1 seat, 1 footrest, 1 carry bag, repair patch





# KAYAK



Surge Elite™ X2

65144





### Compliance / Certification

- User capacity: 2 adults
- Weight capacity: 180 kg (397 lbs)

### Structure Specs

- Inflated size: 3.86 m x 96 cm x 35 cm / 12'8" x 38" x 14"
- Deflated size: 3.85 m x 1.02 m / 12'8" x 40"
- 3 air chamber construction
- Walls made with 1000D Trittech™ - a 3-ply ultra-reinforced material
- Ultra-Fresh® antimicrobial treatment (containing zinc pyrithione technology) is manufactured into the PVC film to protect the surface from odor-causing bacteria, mold and mildew growth
- Firm and rigid inflated floor

### Features & Design

- 2 adjustable seats with storage compartments
- Form-fitted construction prevents water from entering the cockpit
- 2 removable fins in different sizes for directional support in various water conditions
- Safety grab ropes
- 4 carry handles
- Air Hammer™ inflation pump (#62086)
- Two 230 cm (91") aluminum paddle (#62174)
- 2 floor-mounted footrests
- Carry bag for easy transportation and storage

### Valves

- Quick inflation/deflation screw valves

### Packaging

- Full color box
- 1 Ea., 19.4 kg (42.8 lbs)

### Contents

- 1 kayak, 2 paddles, 1 hand pump, 2 fins, 2 seats, 2 footrests, 1 carry bag, repair patch





# KAYAK



Waypoint Elite™ X2

65167

NEW!





### Compliance / Certification

- User capacity: 2 adults
- Weight capacity: 180 kg (397 lbs)

### Structure Specs

- Inflated size: 3.82 m x 1.01 m x 35 cm / 12'6" x 40" x 14"
- Deflated size: 3.87 m x 1.05 m / 12'8" x 41"
- 3 air chamber construction
- Walls made with 1000D Tritech™ - a 3-ply ultra-reinforced material
- Ultra-Fresh® Antimicrobial Surface
- Rigid boat floor made with FortiFiber™ drop stitch construction

### Features & Design

- 2 adjustable seats with storage compartments and inflatable booster pad for elevated seating
- Form-fitted construction prevents water from entering the cockpit
- Durable strake protects against impact and friction
- Keel features a water separator for better tracking and improved speed
- 2 removable fins in different sizes for directional support in various water conditions
- Safety grab ropes
- Oar clasps
- 4 carry handles
- 1 floor-mounted footrest
- Air Hammer™ hand pump with built-in pressure gauge
- Two 230 cm (91") aluminum paddles (#62174)
- Carry bag for easy transportation and storage

### Valves

- Quick inflation/deflation screw valves
- Quick inflation/deflation air valve

### Packaging

- Full color box
- 1 Ea., 22.9 kg (50.4 lbs)

### Contents

- 1 kayak, 2 paddles, 1 hand pump, 2 fins, 2 seats, 1 seat booster pad, 1 footrest, 1 carry bag, repair patch







# Summer

Bestway® has all the makings for summertime fun. Stylish and comfortable lounges make the best summer ever for your customers. Make it a Bestway summer!

**150** Sparkle Shell™  
Play Pool

**151** Luxe Relaxer™  
Lounge

**152** Funky Floral™  
Family Pool





# Sparkle Shell™ Play Pool

**52489 | AGE 3+**

- 1.50 m x 1.27 m x 43 cm / 59" x 50" x 17"
- 2 rings
- Fun shell shape
- Infused with silver glitter that sparkles in the sunlight
- Release pool water with the easy-to-use drain valve
- Water capacity: 230 L (61 gal.)
- Repair patch
- Full color box
- 4 Ea., 8.1 kg (17.8 lbs)





# Luxe Relaxer™ Lounge

**43646**

- 1.53 m x 1.02 m / 60" x 40"
- 2 air chambers
- Comfortable headrest
- Cool mesh bottom
- 1 cup holder
- Heavy-duty handles
- User capacity: 1 adult
- Weight capacity: 90 kg (198 lbs)
- Repair patch
- Full color box
- 8 Ea., 10.9 kg (24.0 lbs)





# Funky Floral™ Family Pool

- Interlocking quick release valves
- 3 rings
- Extra-wide sidewalls
- Fun floral graphics
- Release pool water with the easy-to-use drain valve
- Repair patch
- Full color box

## 54120 | AGE 6+

- 2.29 m x 1.52 m x 56 cm /  
7' 6" x 60" x 22"
- Water capacity: 702 L (185 gal.)
- 2 Ea., 9.7 kg (21.5 lbs)

## 54121 | AGE 6+

- 3.05 m x 1.83 m x 56 cm /  
10' x 6' x 22"
- Water capacity: 1,161 L (307 gal.)
- 2 Ea., 14.7 kg (32.3 lbs)









| ITEM  | NAME PRODUCT                             | PAGE | ITEM  | NAME PRODUCT                             | PAGE |
|-------|------------------------------------------|------|-------|------------------------------------------|------|
| 43646 | Luxe Relaxer™ Lounge                     | 151  | 56995 | Power Steel® Rectangular Pools           | 59   |
| 52489 | Sparkle Shell™ Play Pool                 | 150  | 56996 | Power Steel® Rectangular Pools           | 59   |
| 54120 | Funky Floral™ Family Pool                | 152  | 56997 | Power Steel® Rectangular Pools           | 59   |
| 54121 | Funky Floral™ Family Pool                | 152  | 56998 | Power Steel® Rectangular Pools           | 59   |
| 5614X | Steel Pro MAX™ Pools                     | 49   | 57266 | Fast Set™ Pools                          | 33   |
| 5614Z | Steel Pro MAX™ Pools                     | 49   | 57269 | Fast Set™ Pools                          | 33   |
| 5618X | Steel Pro MAX™ Pools                     | 53   | 57270 | Fast Set™ Pools                          | 33   |
| 5618Y | Steel Pro MAX™ Pools                     | 53   | 57289 | Fast Set™ Pools                          | 33   |
| 5619D | Steel Pro MAX™ Pools                     | 53   | 57307 | Fast Set™ Pools                          | 33   |
| 5619E | Steel Pro MAX™ Pools                     | 53   | 58517 | Swimfinity™ Swim Fitness System          | 68   |
| 5619G | Steel Pro MAX™ Pools                     | 53   | 58612 | Round Pool Dome                          | 70   |
| 5619H | Steel Pro MAX™ Pools                     | 53   | 58639 | Floor Protector                          | 71   |
| 5619K | Steel Pro MAX™ Pools                     | 51   | 60003 | Cancun Signature AirJet™                 | 84   |
| 5619N | Steel Pro MAX™ Pools                     | 47   | 60013 | Paris Luxe AirJet™                       | 88   |
| 5619Q | Power Steel® Rectangular Pools           | 61   | 60017 | Palm Springs AirJet™                     | 92   |
| 561FS | Steel Pro® Rectangular Pools             | 41   | 60027 | Vancouver FortiFiber™ Smart AirJet Plus™ | 102  |
| 561FT | Steel Pro® Rectangular Pools             | 41   | 60061 | Aruba Signature AirJet™                  | 80   |
| 561FU | Steel Pro® Rectangular Pools             | 41   | 60067 | Mauritius Smart AirJet™                  | 96   |
| 561FV | Steel Pro® Rectangular Pools             | 41   | 60163 | Toronto ThermaCore™ Smart AirJet Plus™   | 108  |
| 56488 | Steel Pro MAX™ Pools                     | 55   | 60165 | Dominica Smart HydroJet™                 | 118  |
| 56677 | Steel Pro® Round Pools                   | 39   | 60167 | Cabo Smart HydroJet™                     | 114  |
| 56678 | Steel Pro® Round Pools                   | 39   | 60317 | EnergySense™ Thermal Spa Cover Round     | 122  |
| 56679 | Steel Pro® Round Pools                   | 39   | 60318 | EnergySense™ Thermal Spa Cover Round     | 122  |
| 56680 | Steel Pro® Round Pools                   | 39   | 60319 | EnergySense™ Thermal Spa Cover Square    | 123  |
| 56681 | Steel Pro® Round Pools                   | 39   | 60326 | EnergySense™ Thermal Spa Cover Round     | 122  |
| 56686 | Steel Pro MAX™ Pools                     | 55   | 60330 | EnergySense™ Thermal Spa Cover Round     | 122  |
| 56706 | Steel Pro® Round Pools                   | 39   | 60331 | EnergySense™ Thermal Spa Cover Round     | 122  |
| 56709 | Steel Pro MAX™ Pools                     | 45   | 60332 | EnergySense™ Thermal Spa Cover Square    | 123  |
| 56721 | Power Steel® Rectangular Pools           | 59   | 60333 | EnergySense™ Thermal Spa Cover Square    | 123  |
| 56722 | Power Steel® Rectangular Pools           | 59   | 65143 | Surge Elite™ X1                          | 142  |
| 56727 | Power Steel® Rectangular Pools           | 59   | 65144 | Surge Elite™ X2                          | 144  |
| 56728 | Power Steel® Rectangular Pools           | 59   | 65167 | Waypoint Elite™ X2                       | 146  |
| 56731 | Steel Pro MAX™ Pools                     | 45   | 65340 | Sea Breeze Set                           | 130  |
| 56946 | Power Steel® Swim Vista Series™ II Pools | 65   | 65341 | White Cap Convertible Set                | 132  |
| 56985 | Steel Pro® Round Pools                   | 37   | 65346 | Huaka'i Set                              | 136  |
| 56986 | Steel Pro® Round Pools                   | 37   | 65377 | Breeze Panorama™ Set                     | 134  |



| ITEM  | NAME PRODUCT                                                   | PAGE |
|-------|----------------------------------------------------------------|------|
| 69612 | AlpineLite™ Insulated Regular Mummy Sleeping Pad               | 16   |
| 69613 | AlpineLite™ Insulated Wide Mummy Sleeping Pad                  | 17   |
| 69615 | WanderLite™ Regular Rectangular Sleeping Pad                   | 14   |
| 69616 | WanderLite™ Large Rectangular Sleeping Pad                     | 15   |
| 69617 | AdventuRest™ Insulated Regular Rectangular Sleeping Pad        | 18   |
| 69618 | AdventuRest™ Insulated Large Rectangular Sleeping Pad          | 19   |
| 69619 | AdventuRest™ Insulated Queen Sleeping Pad                      | 20   |
| 69620 | TerrainLite™ Self-Inflating Regular Mummy Sleeping Pad         | 22   |
| 69621 | TerrainPro™ Self-Inflating Regular Mummy Sleeping Pad          | 23   |
| 69622 | ComforTrek™ Self-Inflating Wide Rectangular Sleeping Pad       | 24   |
| 69623 | ComforTrek™ Luxe Self-Inflating Large Rectangular Sleeping Pad | 25   |
| 69624 | WanderLite™ Regular Air Pillow                                 | 26   |
| 69625 | AlpineLite™ Large Air Pillow                                   | 27   |





# SPECIAL EDITION 2024

## SHANGHAI

Bestway Inflatables & Material Corp.  
No. 208 Jin Yuan Wu Road,  
Shanghai, 201812, China  
Tel: +86 21 6913 5588  
E-mail: [info@bestwaycorp.com](mailto:info@bestwaycorp.com)

## HONG KONG

Bestway (Hong Kong) International Ltd.  
Suite 713, 7/Floor, East Wing, Tsim Sha Tsui Centre,  
66 Mody Road, Kowloon, Hong Kong  
Tel: +852 2997 7169  
E-mail: [info@bestwaycorp.hk](mailto:info@bestwaycorp.hk)

## U.S.A.

Bestway (USA) Inc.  
3435 S. McQueen Road, Chandler,  
AZ 85286, United States of America  
Tel: +1 480 838 3888  
E-mail: [info@bestwaycorp.us](mailto:info@bestwaycorp.us)

## EUROPE

Bestway Europe S.p.a.  
Via Resistenza, 5  
20098 San Giuliano M.se (MI), Italy  
Tel: +39 02 9884 881  
E-mail: [info@bestwaycorp.eu](mailto:info@bestwaycorp.eu)

## EASTERN EUROPE

Bestway Eastern Europe Sp. z o.o.  
Ul. Ekologiczna 24  
05-080 Klaudyn Poland  
Tel: +48 22 60 22 508  
E-mail: [info@bestwaycorp.pl](mailto:info@bestwaycorp.pl)

## LATIN AMERICA

Bestway Central & South America Ltda  
Salar Ascotan 1282, Parque Enea,  
Pudahuel, Santiago, Chile  
Tel: +562 3203 6438  
E-mail: [info@bestwaycorp.lat](mailto:info@bestwaycorp.lat)

## BRAZIL

Bestway Brazil  
Av Cerro Azul, 2783 Maringá - PR - Brazil  
Zip Code: 87010-055  
Tel: +55 44 3046 2950 / +0800 001 8400  
E-mail: [info@bestwaycorp.com.br](mailto:info@bestwaycorp.com.br)

## AUSTRALIA

Bestway Australia Pty Limited  
Unit 2/98-104 Carnarvon St  
Silverwater, NSW 2128, Australia  
Tel: +61 2 9037 1388  
E-mail: [info@bestwaycorp.com.au](mailto:info@bestwaycorp.com.au)

## FRANCE

Bestway France Sarl  
1681 route des Dolines - Les Taissounières - Belem  
06560 VALBONNE  
Tel: +33 4 97 04 92 99  
E-mail: [info@bestwaycorp.fr](mailto:info@bestwaycorp.fr)

## GERMANY

Bestway Deutschland GmbH  
Parkstraße 11  
24534 Neumünster, Germany  
Tel: +49 4321 555 05 - 0  
E-mail: [info@bestwaycorp.de](mailto:info@bestwaycorp.de)

## SCANDINAVIA

Bestway Scandinavia A/S  
Amagertorv 17, 3<sup>rd</sup> Fl  
DK-1160 Copenhagen K Denmark  
Tel: +45 78744569  
E-mail: [info@bestwaycorp.scandinavia.eu](mailto:info@bestwaycorp.scandinavia.eu)



**Bestway**



[www.bestwaycorp.com](http://www.bestwaycorp.com)

©2023 Bestway Inflatables & Material Corp. All rights reserved.  
®™ Trademarks owned and managed by Bestway Inflatables & Material Corp.